

C 4128 V SKF

CARB toroidal roller bearings

TYPE: Roller bearings, Toroidal CARB, Full complement, cylindrical bore

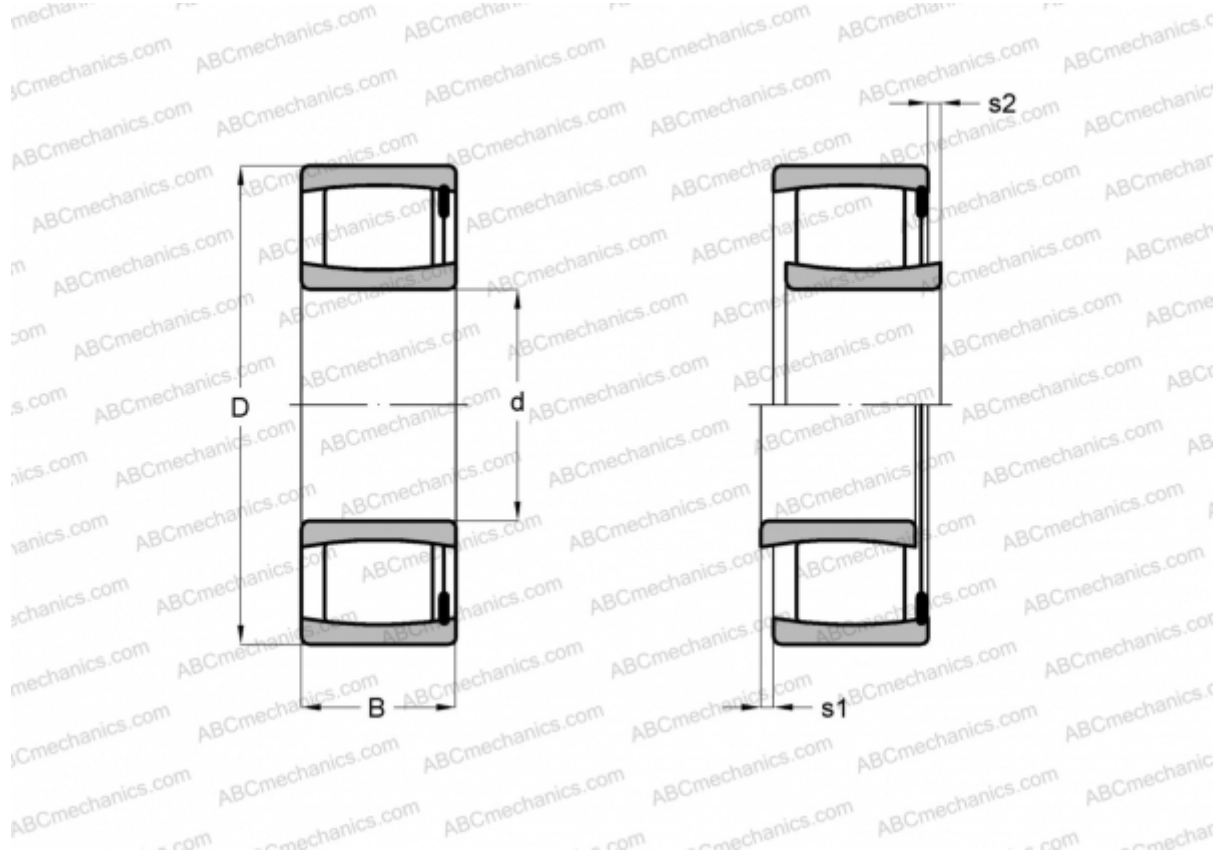

Technical specification

DIMENSIONS, MM

d	140,000
D	225,000
B	85,000

WEIGHT, KG 14,200

MANUFACTURER [SKF](#)

CALCULATION DATA

Basic dynamic load rating, C	1000,000 kN
Basic static load rating, Co	1600,000 kN
Fatigue load limit, Pu	153,000 kN
Limiting speed	630 r/min