

## C 4034 V SKF

CARB toroidal roller bearings

TYPE: Roller bearings, Toroidal CARB, Full complement, cylindrical bore

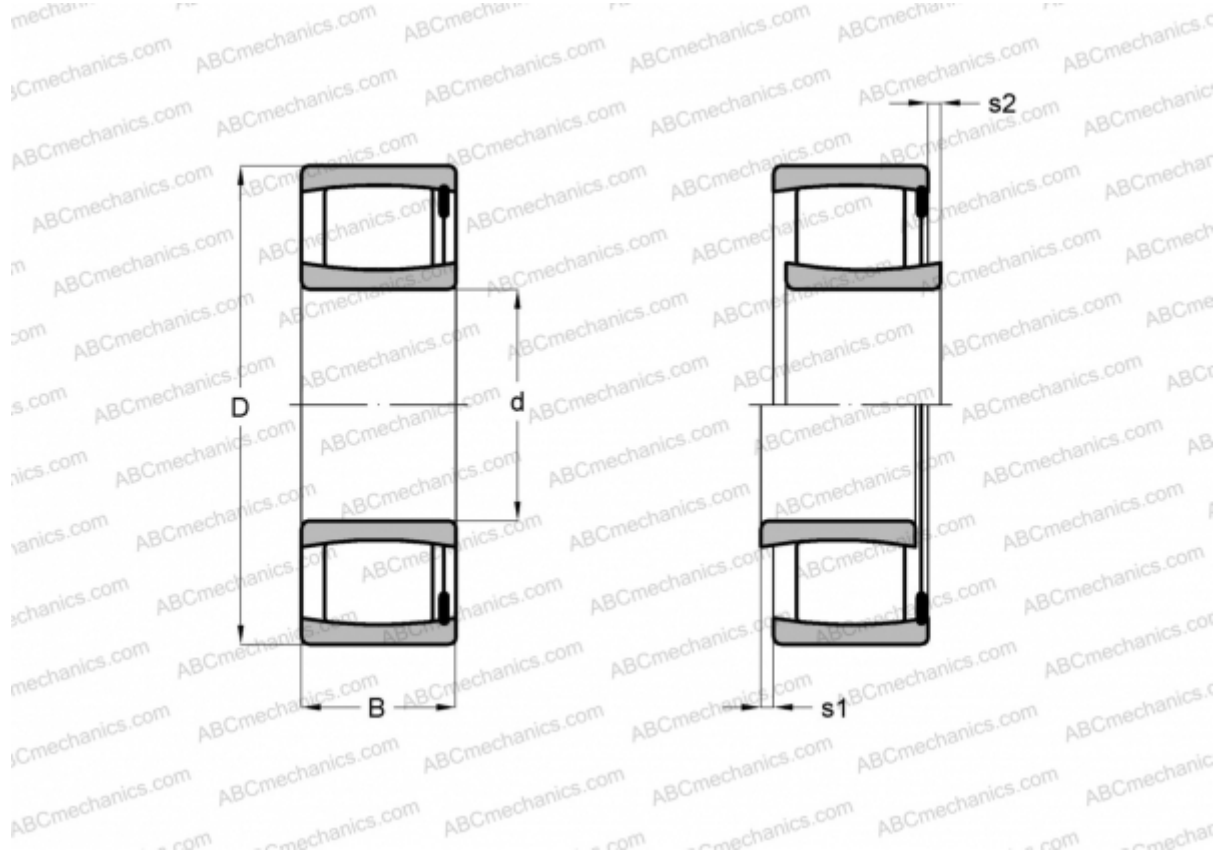

### Technical specification

#### DIMENSIONS, MM

d	170,000
D	260,000
B	90,000

**WEIGHT, KG** 17,500

**MANUFACTURER** [SKF](#)

#### CALCULATION DATA

Basic dynamic load rating, C	1140,000 kN
Basic static load rating, Co	1860,000 kN
Fatigue load limit, Pu	170,000 kN
Limiting speed	500 r/min