

C 4026-2CS5V SKF

CARB toroidal roller bearings

TYPE: Roller bearings, Toroidal CARB, Full complement, seals

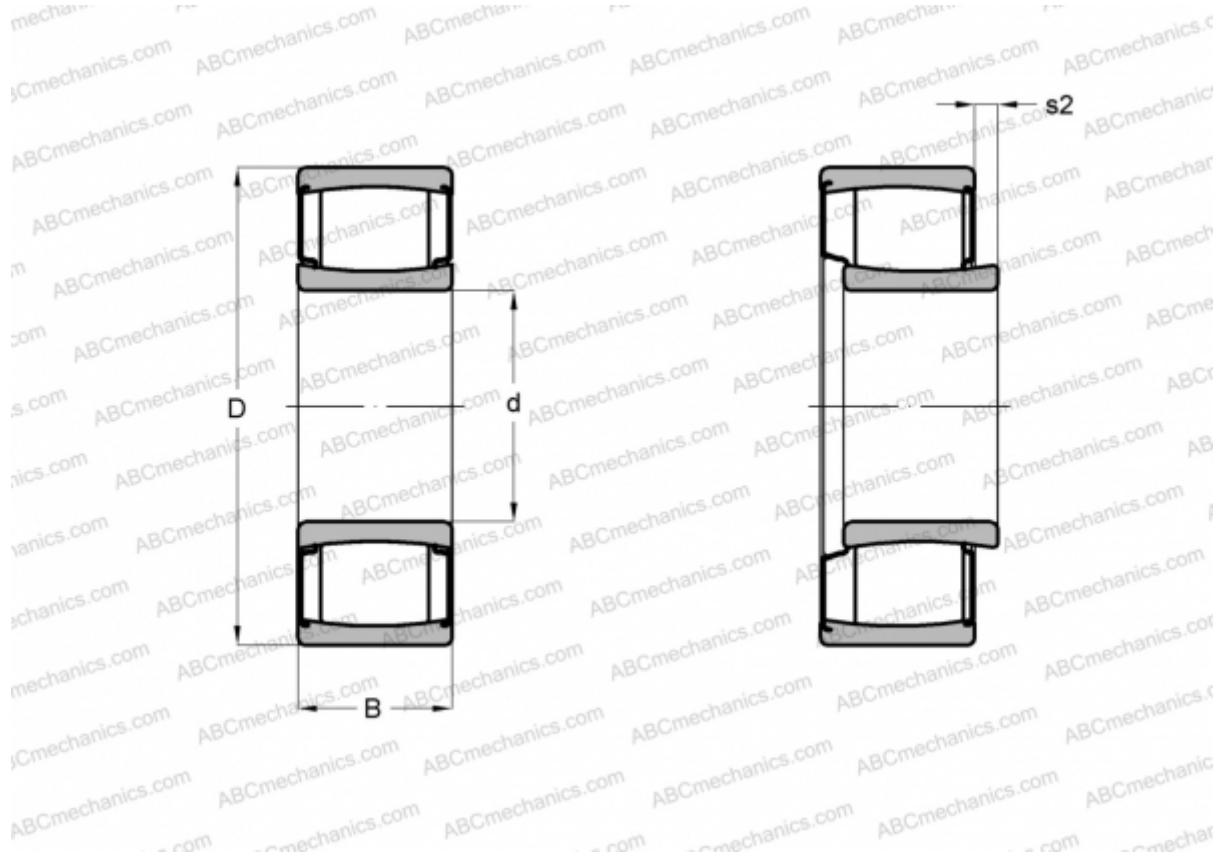

Technical specification

DIMENSIONS, MM

d	130,000
D	200,000
B	69,000

WEIGHT, KG 7,500

MANUFACTURER [SKF](#)

CALCULATION DATA

Basic dynamic load rating, C	550,000 kN
Basic static load rating, Co	830,000 kN
Fatigue load limit, Pu	85,000 kN
Limiting speed	70 r/min