

C 4126-2CS5V SKF

CARB toroidal roller bearings

TYPE: Roller bearings, Toroidal CARB, Full complement, seals

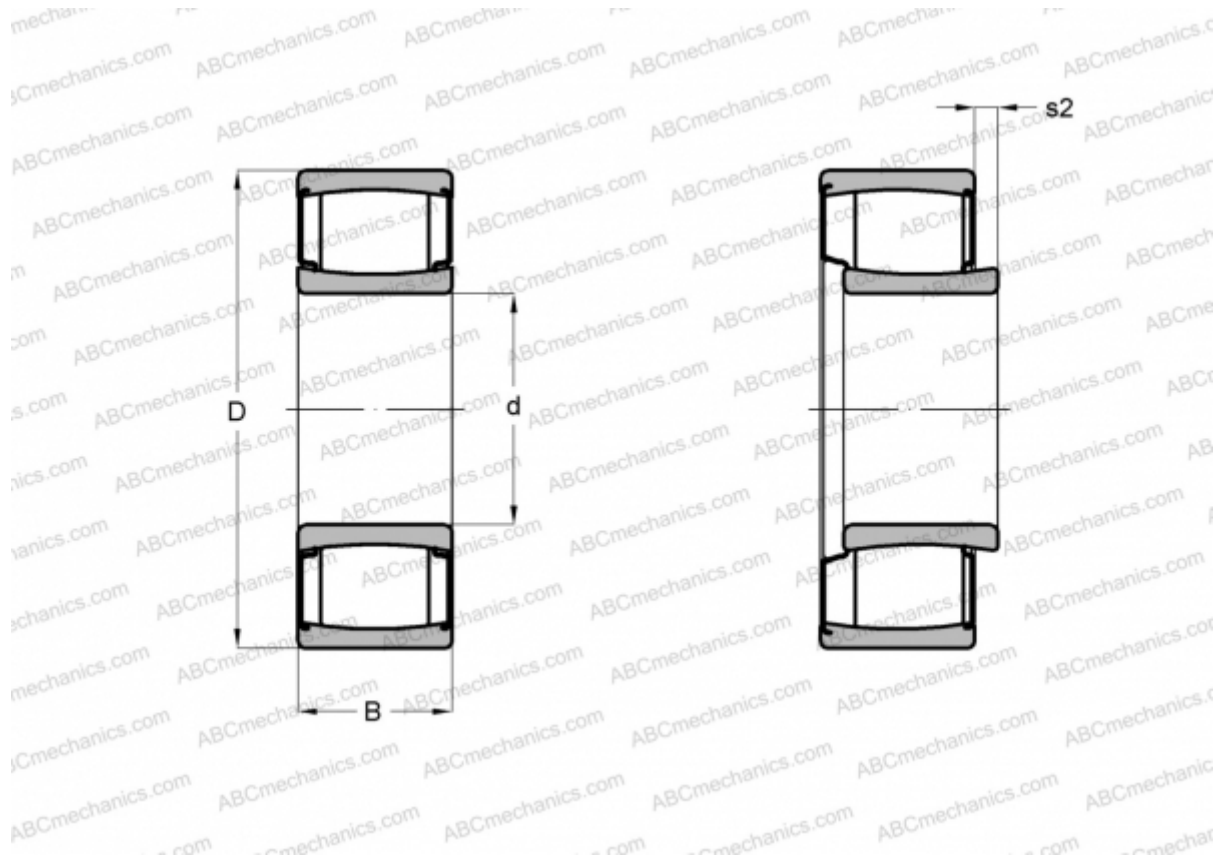

Technical specification

DIMENSIONS, MM

d	130,000
D	210,000
B	80,000

WEIGHT, KG 10,500

MANUFACTURER [SKF](#)

CALCULATION DATA

Basic dynamic load rating, C	750,000 kN
Basic static load rating, Co	1100,000 kN
Fatigue load limit, Pu	108,000 kN
Limiting speed	70 r/min