

C 4128-2CS5V SKF

CARB toroidal roller bearings

TYPE: Roller bearings, Toroidal CARB, Full complement, seals

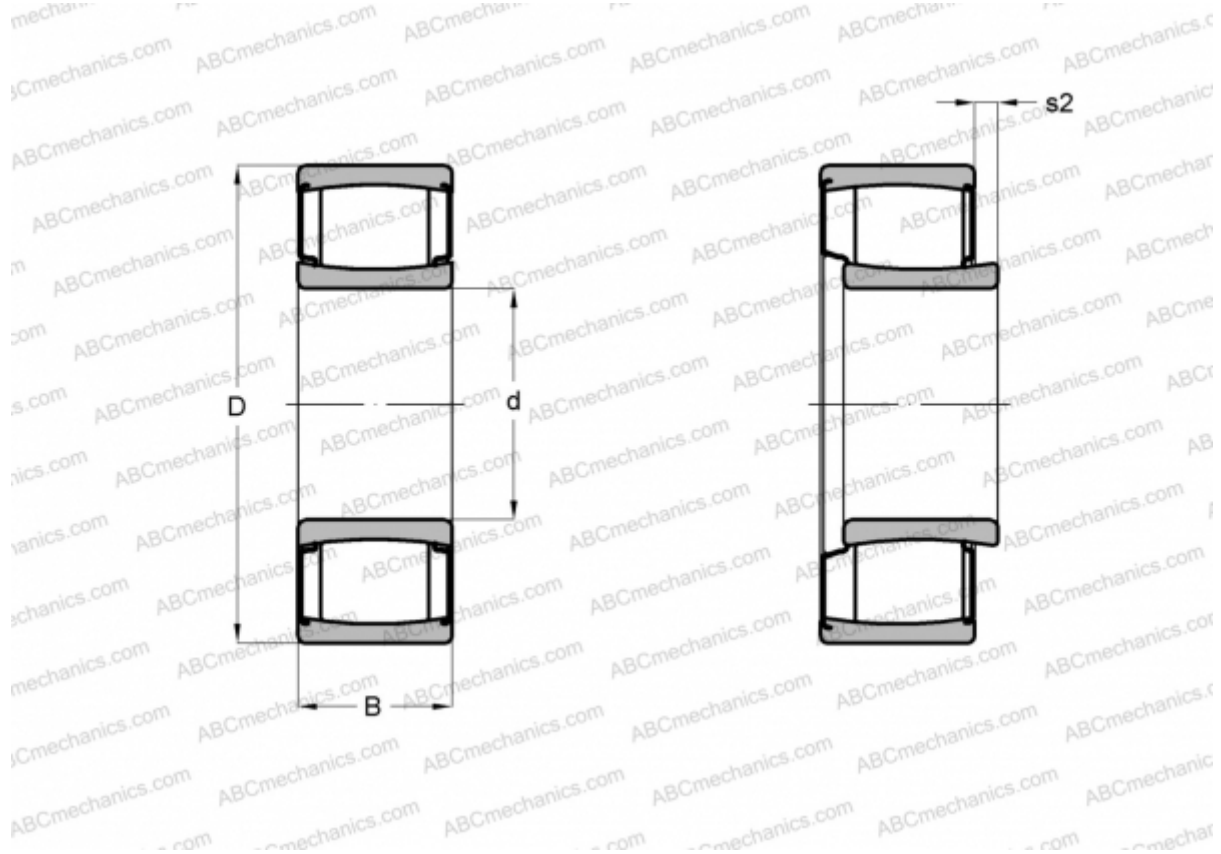

Technical specification

DIMENSIONS, MM

d	140,000
D	225,000
B	85,000

WEIGHT, KG 12,500

MANUFACTURER [SKF](#)

CALCULATION DATA

Basic dynamic load rating, C	780,000 kN
Basic static load rating, Co	1200,000 kN
Fatigue load limit, Pu	116,000 kN
Limiting speed	63 r/min