

C 4030-2CS5V SKF

CARB toroidal roller bearings

TYPE: Roller bearings, Toroidal CARB, Full complement, seals

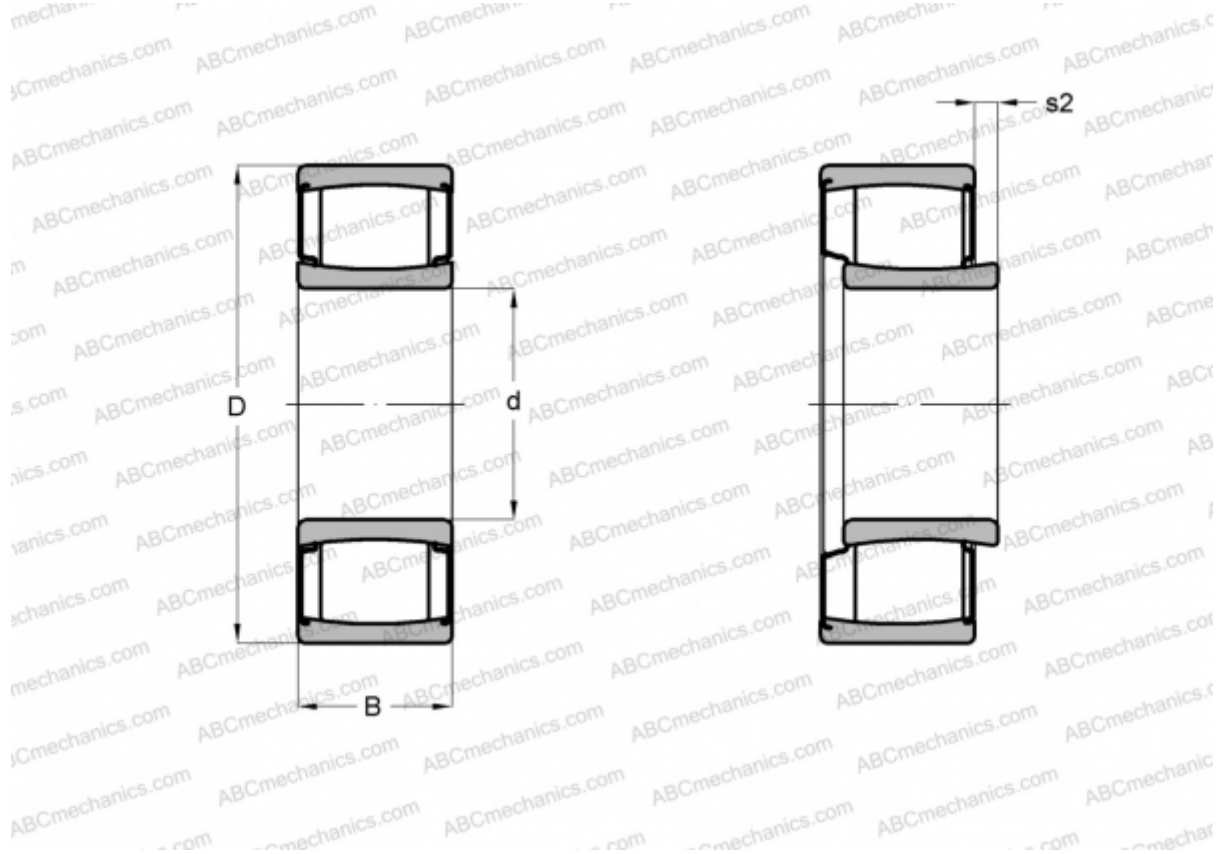

Technical specification

DIMENSIONS, MM

d	150,000
D	225,000
B	75,000

WEIGHT, KG 10,000

MANUFACTURER [SKF](#)

CALCULATION DATA

Basic dynamic load rating, C	585,000 kN
Basic static load rating, Co	965,000 kN
Fatigue load limit, Pu	93,000 kN
Limiting speed	63 r/min