

C 4034-2CS5V SKF

CARB toroidal roller bearings

TYPE: Roller bearings, Toroidal CARB, Full complement, seals

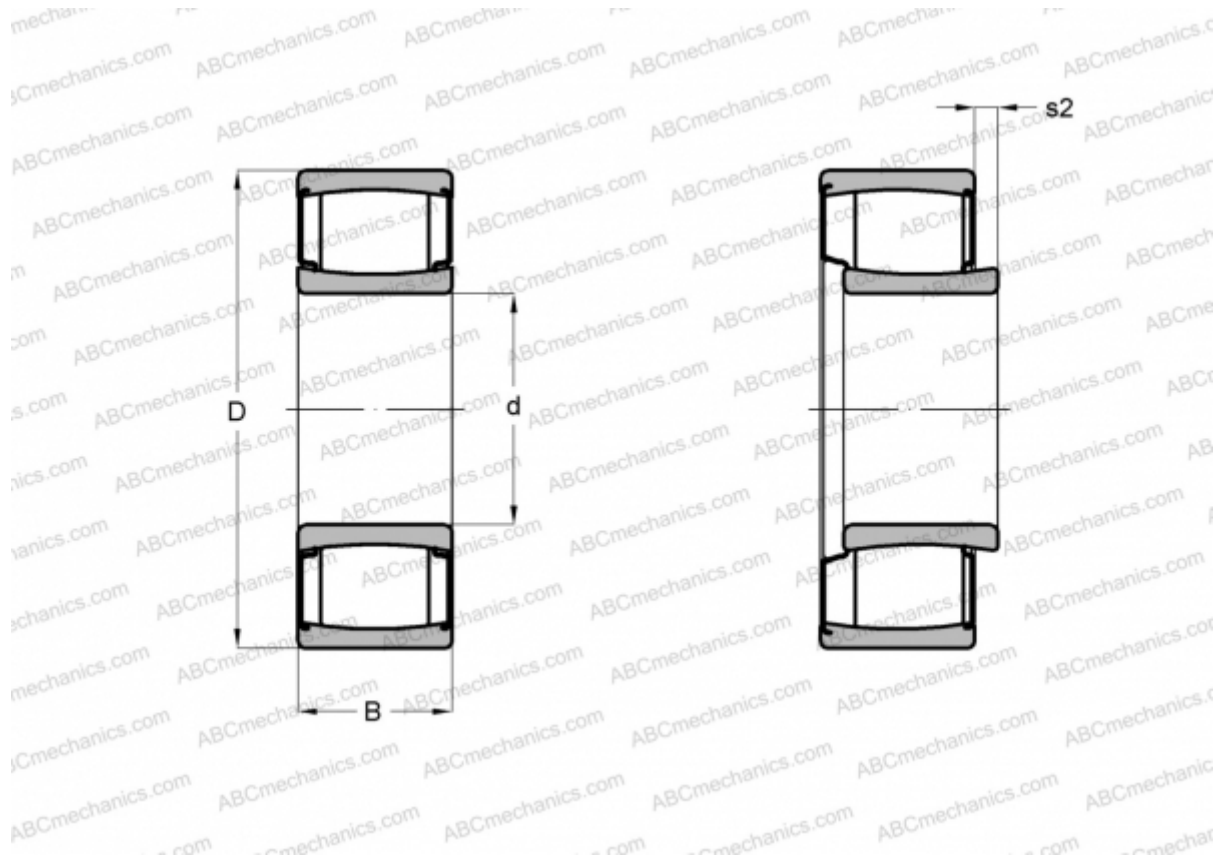

Technical specification

DIMENSIONS, MM

d	170,000
D	260,000
B	90,000

WEIGHT, KG 17,000

MANUFACTURER [SKF](#)

CALCULATION DATA

Basic dynamic load rating, C	965,000 kN
Basic static load rating, Co	1630,000 kN
Fatigue load limit, Pu	150,000 kN
Limiting speed	53 r/min