

C 4036-2CS5V SKF

CARB toroidal roller bearings

TYPE: Roller bearings, Toroidal CARB, Full complement, seals

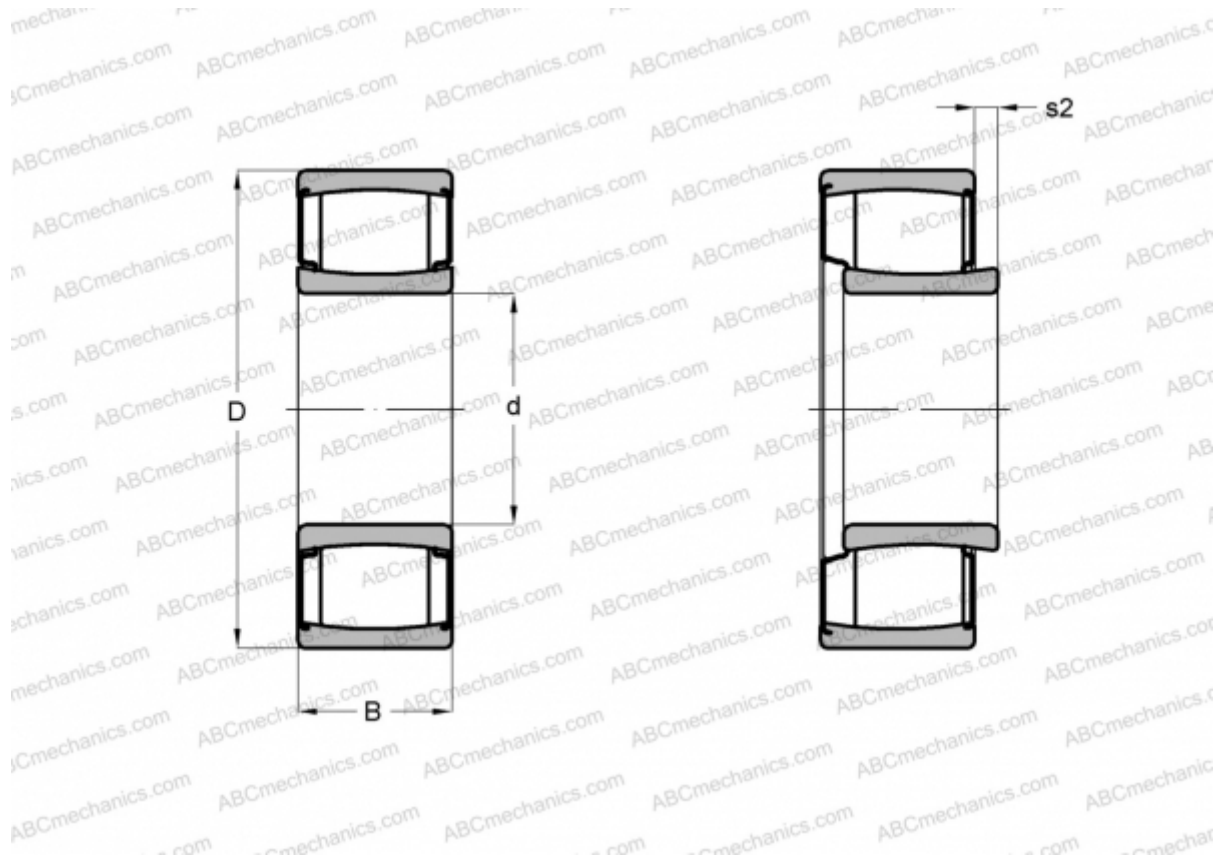

Technical specification

DIMENSIONS, MM

d	180,000
D	280,000
B	100,000

WEIGHT, KG 23,500

MANUFACTURER [SKF](#)

CALCULATION DATA

Basic dynamic load rating, C	1320,000 kN
Basic static load rating, Co	2120,000 kN
Fatigue load limit, Pu	193,000 kN
Limiting speed	53 r/min