

C 4136-2CS5V SKF

CARB toroidal roller bearings

TYPE: Roller bearings, Toroidal CARB, Full complement, seals

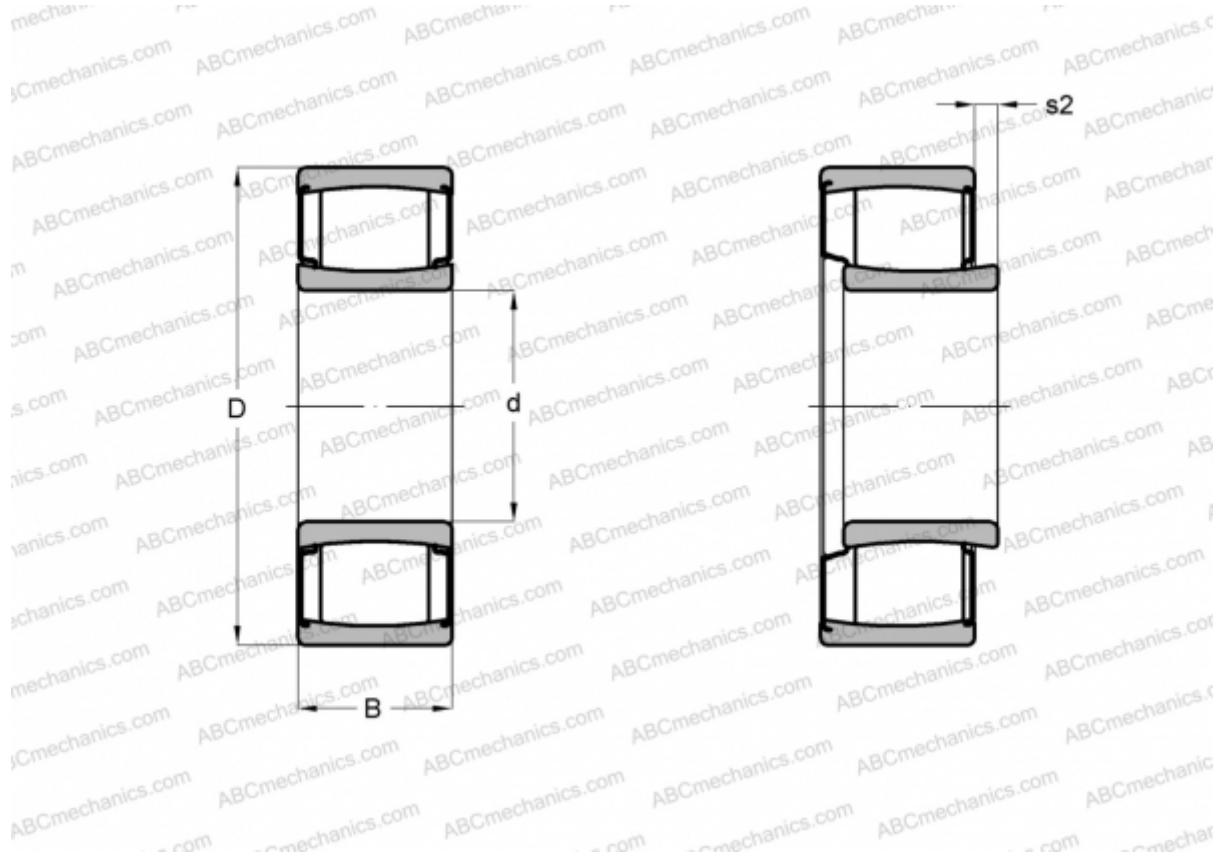

Technical specification

DIMENSIONS, MM

d	180,000
D	300,000
B	118,000

WEIGHT, KG 35,000

MANUFACTURER [SKF](#)

CALCULATION DATA

Basic dynamic load rating, C	1760,000 kN
Basic static load rating, Co	2700,000 kN
Fatigue load limit, Pu	240,000 kN
Limiting speed	48 r/min