

C 4038-2CS5V SKF

CARB toroidal roller bearings

TYPE: Roller bearings, Toroidal CARB, Full complement, seals

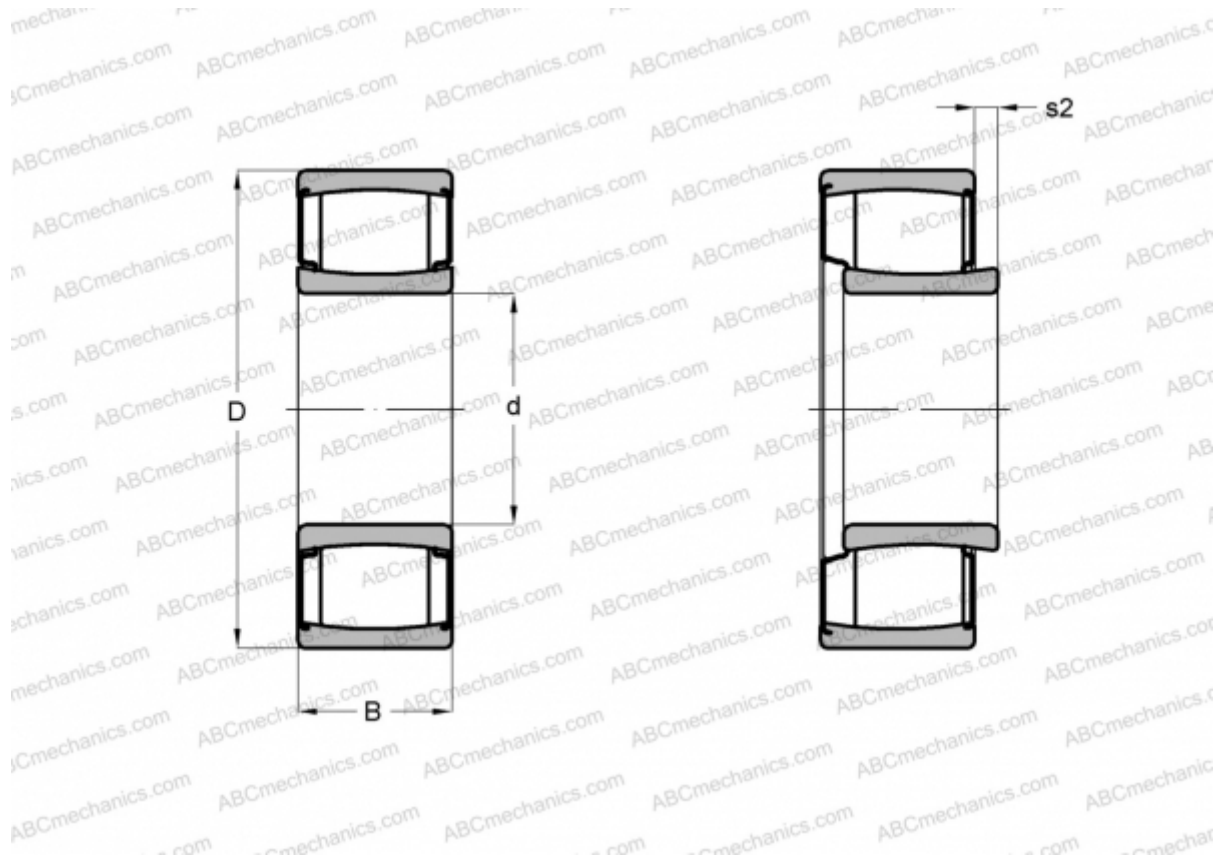

Technical specification

DIMENSIONS, MM

d	190,000
D	290,000
B	100,000

WEIGHT, KG 24,500

MANUFACTURER [SKF](#)

CALCULATION DATA

Basic dynamic load rating, C	1370,000 kN
Basic static load rating, Co	2320,000 kN
Fatigue load limit, Pu	204,000 kN
Limiting speed	48 r/min