

C 4138-2CS5V SKF

CARB toroidal roller bearings

TYPE: Roller bearings, Toroidal CARB, Full complement, seals

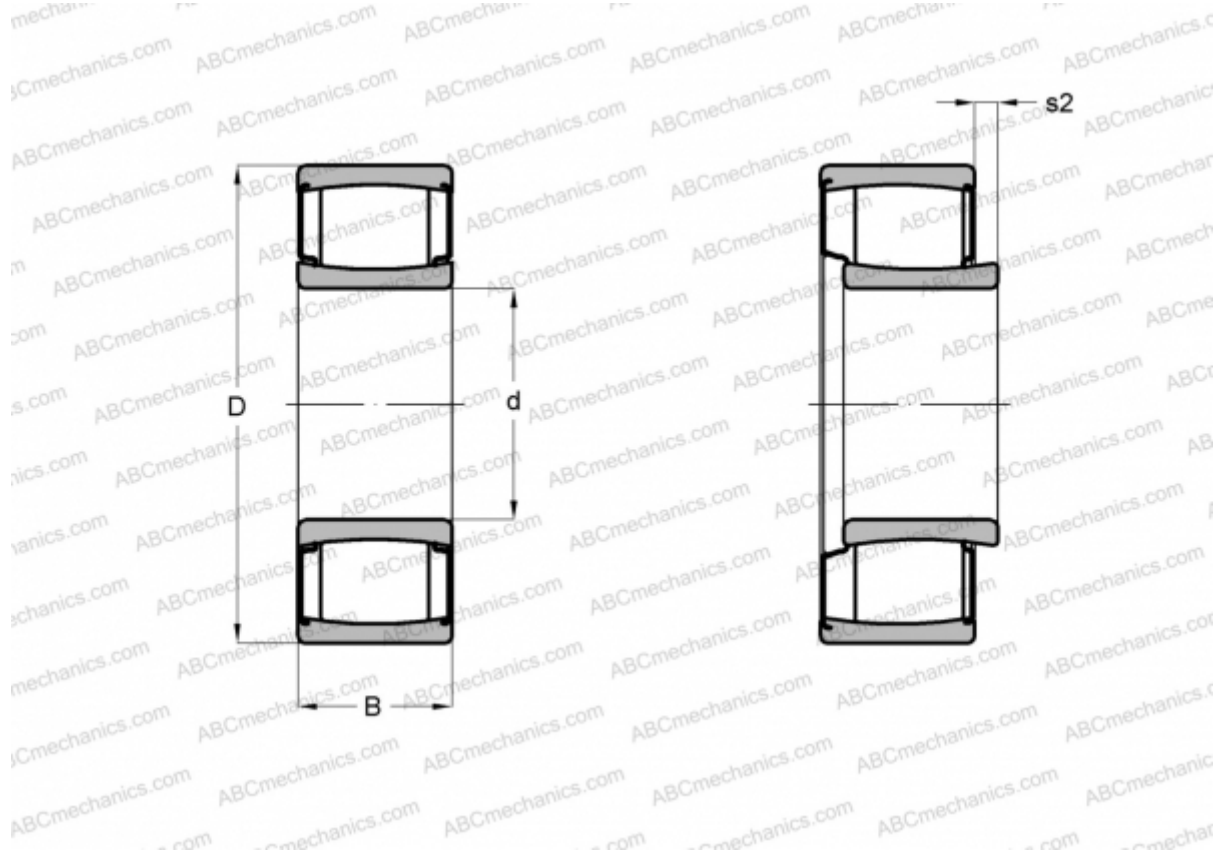

Technical specification

DIMENSIONS, MM

d	190,000
D	320,000
B	128,000

WEIGHT, KG 43,500

MANUFACTURER [SKF](#)

CALCULATION DATA

Basic dynamic load rating, C	2040,000 kN
Basic static load rating, Co	3150,000 kN
Fatigue load limit, Pu	275,000 kN
Limiting speed	45 r/min