

C 4040-2CS5V SKF

CARB toroidal roller bearings

TYPE: Roller bearings, Toroidal CARB, Full complement, seals

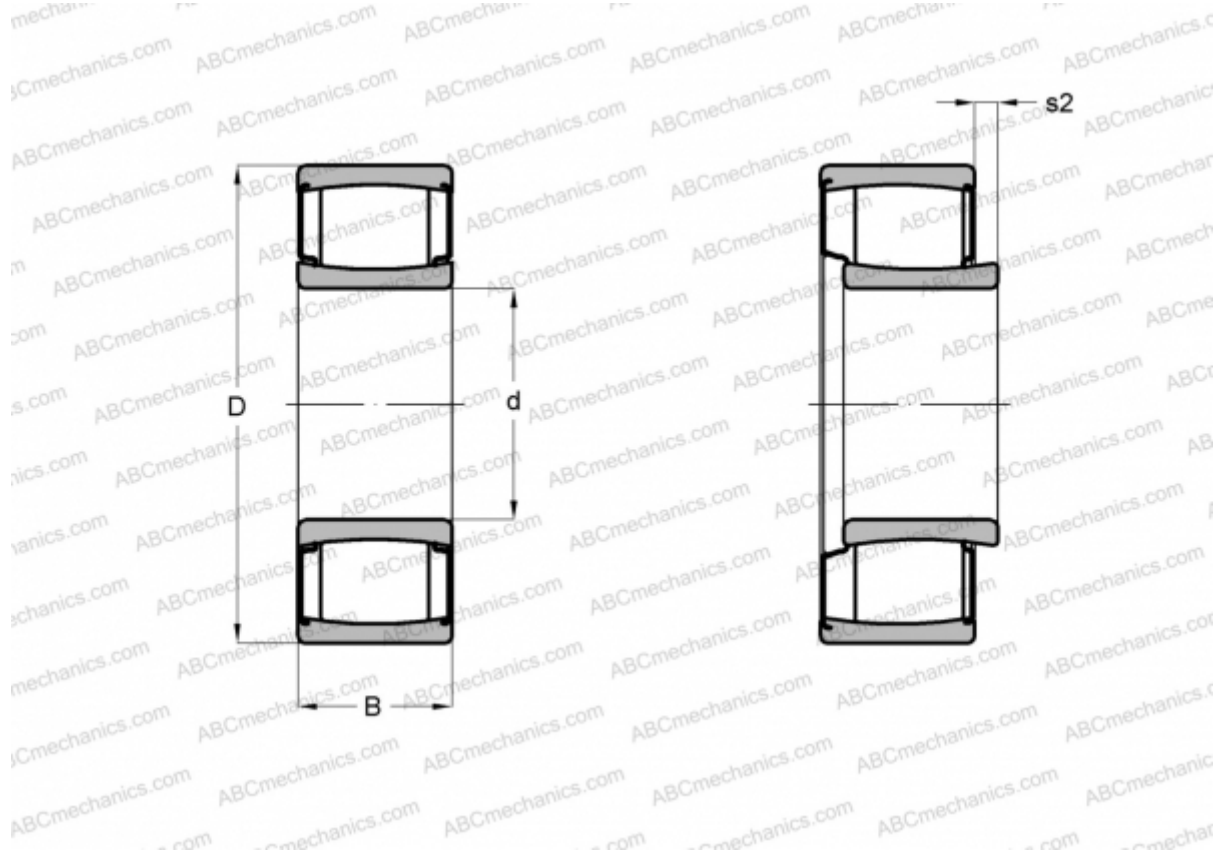

Technical specification

DIMENSIONS, MM

d	200,000
D	310,000
B	109,000

WEIGHT, KG 31,000

MANUFACTURER [SKF](#)

CALCULATION DATA

Basic dynamic load rating, C	1630,000 kN
Basic static load rating, Co	2650,000 kN
Fatigue load limit, Pu	232,000 kN
Limiting speed	45 r/min