

51103 SKF

Thrust ball bearings

TYPE: Ball bearings, Thrust ball bearing, Single direction, Separable

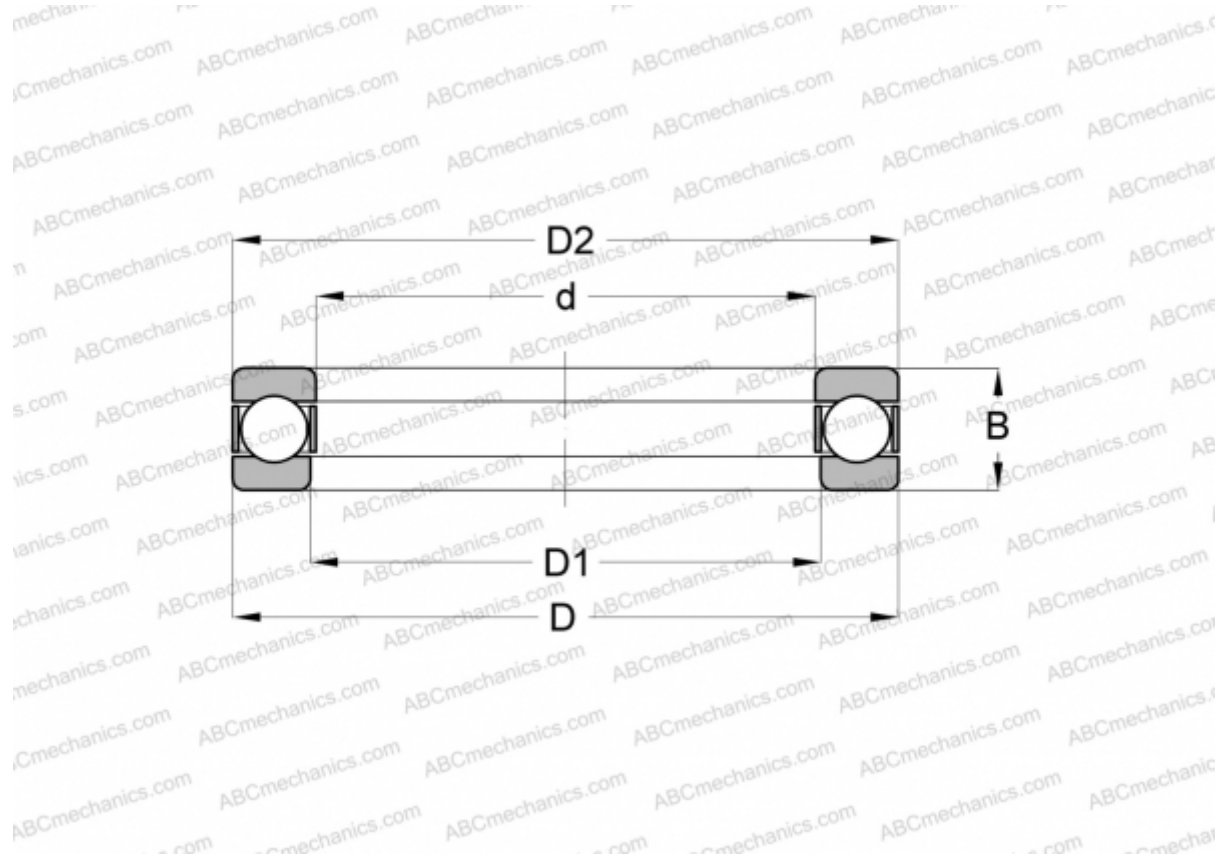

Technical specification

DIMENSIONS, MM

d	17,000
D	30,000
D1	18,000
D2	30,000
B	9,000

WEIGHT, KG 0,025

MANUFACTURER [SKF](#)

INTERCHANGE

ABC	51103
FAG	51103
RIV	ELP 17
RHP	51103
SNR	51103

INTERCHANGE

STEYR [51103](#)

CALCULATION DATA

Basic dynamic load rating, C	11,400 kN
Basic static load rating, Co	21,200 kN
Fatigue load limit, Pu	0,780 kN
Limiting speed	8500 r/min
Attainable speed for grease lubrication	12000 r/min