

51208 STEYR

Thrust ball bearings

TYPE: Ball bearings, Thrust ball bearing, Single direction, Separable

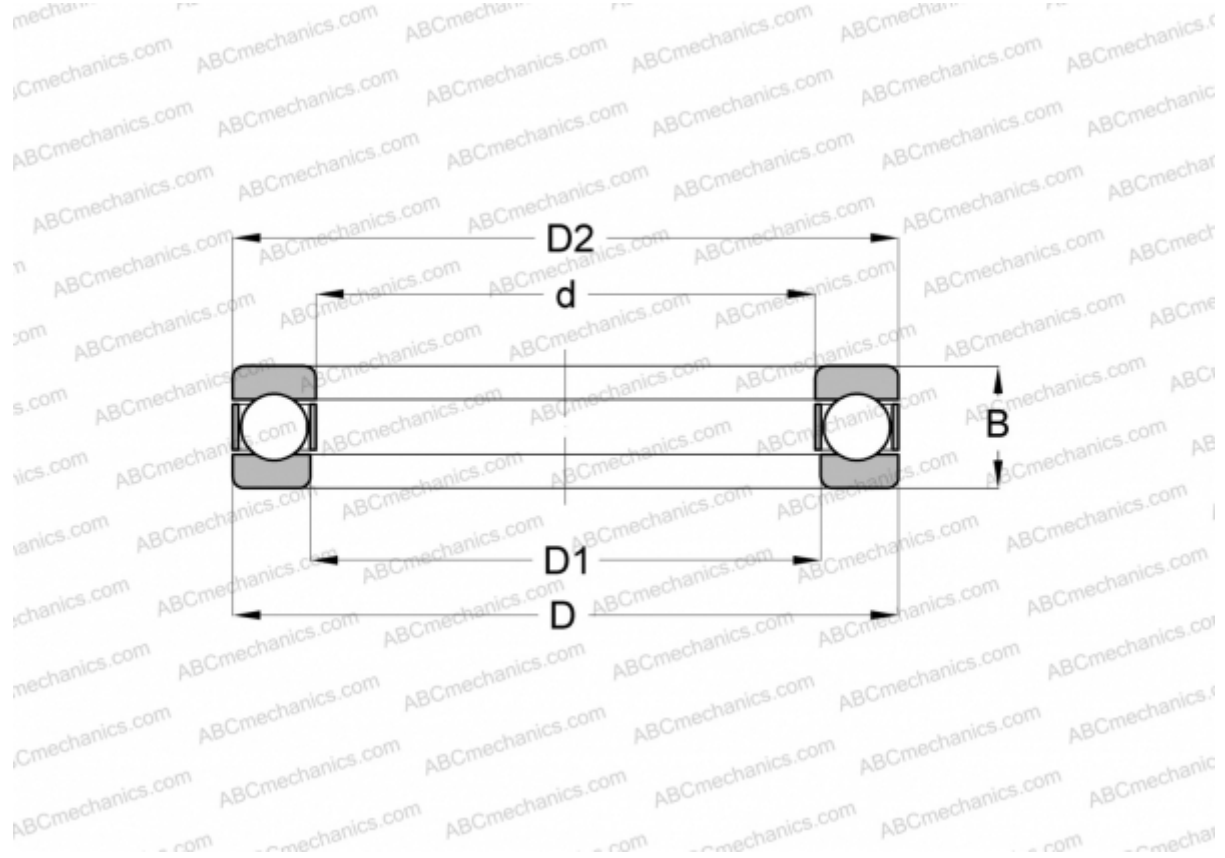

Technical specification

DIMENSIONS, MM

d	40,000
D	68,000
D1	42,000
D2	68,000
B	19,000

WEIGHT, KG 0,259

MANUFACTURER [STEYR](#)

INTERCHANGE

ABC	51208
FAG	51208
RIV	LP 40
RHP	51208
SKF	51208

INTERCHANGE

SNR	51208
-----	-----------------------