

51209 SKF

Thrust ball bearings

TYPE: Ball bearings, Thrust ball bearing, Single direction, Separable

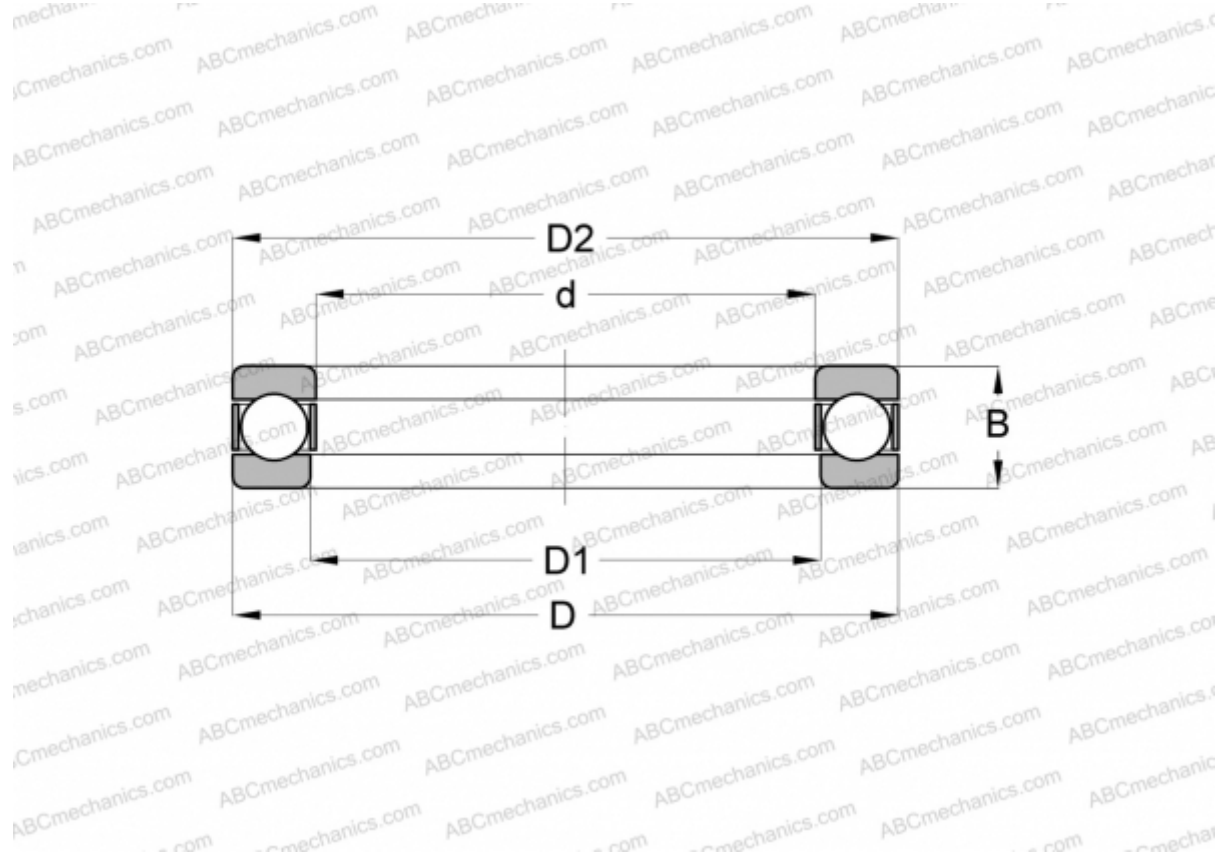

Technical specification

DIMENSIONS, MM

d	45,000
D	73,000
D1	47,000
D2	73,000
B	20,000

WEIGHT, KG 0,300

MANUFACTURER [SKF](#)

INTERCHANGE

ABC	51209
FAG	51209
RIV	LP 45
RHP	51209
SNR	51209

INTERCHANGE

STEYR [51209](#)

CALCULATION DATA

Basic dynamic load rating, C	39,000 kN
Basic static load rating, Co	86,500 kN
Fatigue load limit, Pu	3,200 kN
Limiting speed	3600 r/min
Attainable speed for grease lubrication	5000 r/min