

51111 SKF

Thrust ball bearings

TYPE: Ball bearings, Thrust ball bearing, Single direction, Separable

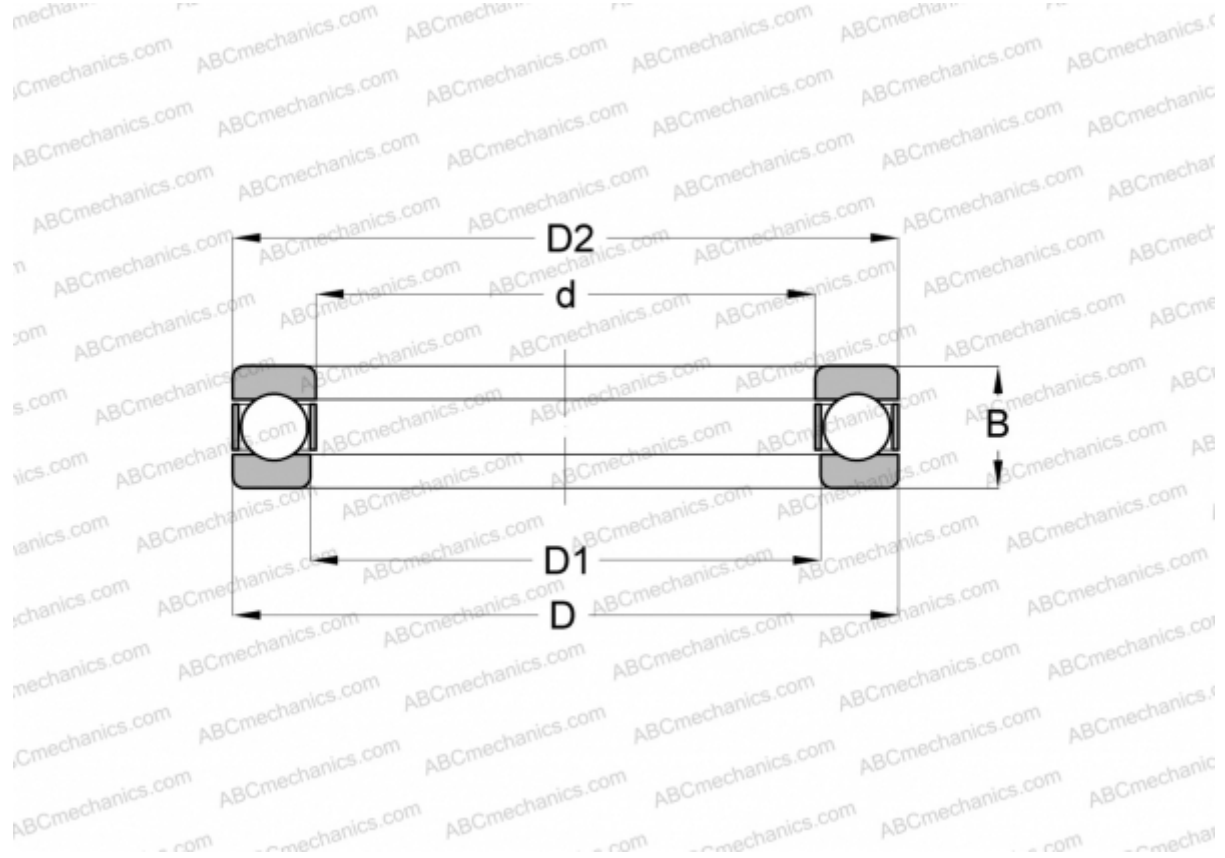

Technical specification

DIMENSIONS, MM

d	55,000
D	78,000
D1	57,000
D2	78,000
B	16,000

WEIGHT, KG 0,230

MANUFACTURER [SKF](#)

INTERCHANGE

ABC	51111
FAG	51111
RIV	ELP 55
RHP	51111
SNR	51111

INTERCHANGE

STEYR [51111](#)

CALCULATION DATA

Basic dynamic load rating, C	30,700 kN
Basic static load rating, Co	85,000 kN
Fatigue load limit, Pu	3,100 kN
Limiting speed	3800 r/min
Attainable speed for grease lubrication	5300 r/min