

51280 RHP

Thrust ball bearings

TYPE: Ball bearings, Thrust ball bearing, Single direction, Separable

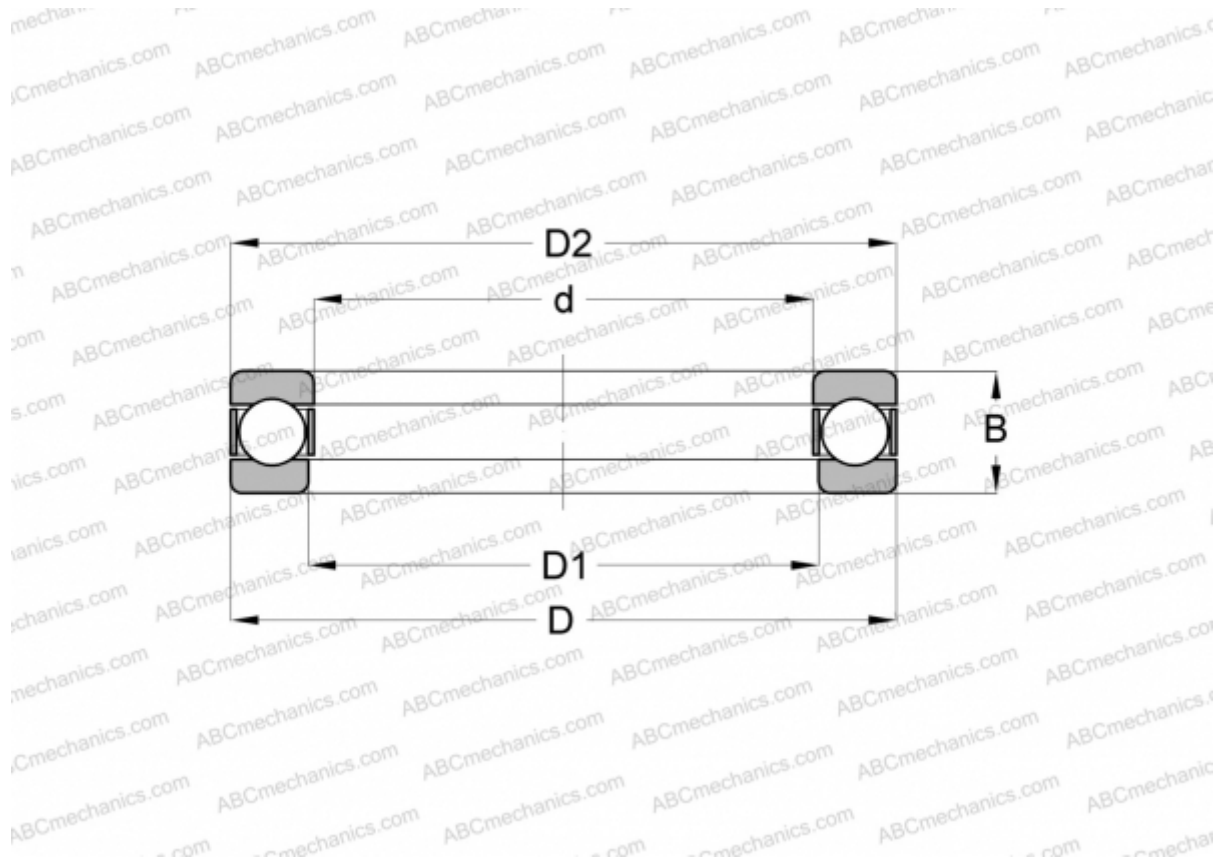

Technical specification

DIMENSIONS, MM

d	400,000
D	540,000
D1	405,000
D2	535,000
B	112,000

WEIGHT, KG 77,111

MANUFACTURER [RHP](#)

INTERCHANGE

ABC	51280
FAG	51280
SNR	51280