

29412 E FAG

Spherical roller thrust bearings

TYPE: Roller bearings, Thrust roller bearing, Axial spherical

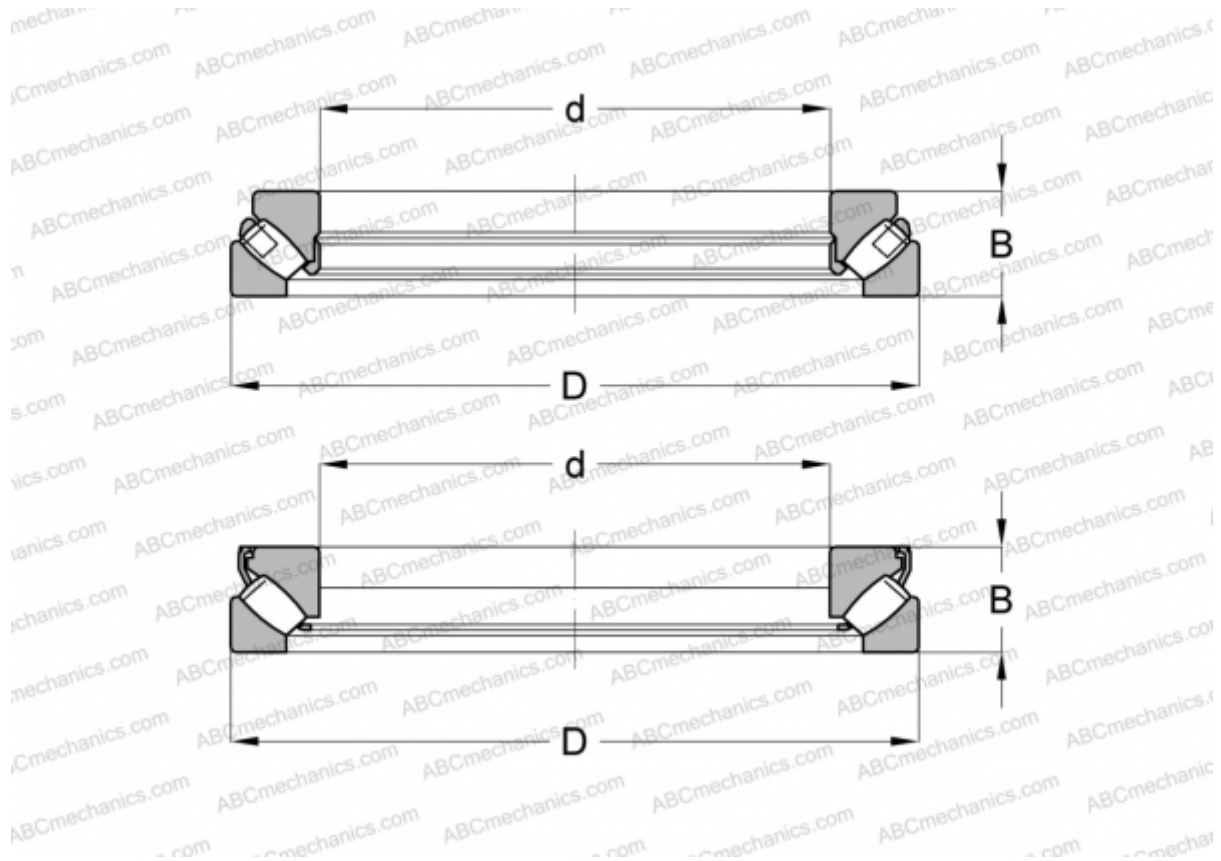

Technical specification

DIMENSIONS, MM

d	60,000
D	130,000
B	42,000

WEIGHT, KG 2,191

MANUFACTURER [FAG](#)

INTERCHANGE

ABC	29412E
SKF	29412 E