

29412 E SKF

Spherical roller thrust bearings

TYPE: Roller bearings, Thrust roller bearing, Axial spherical

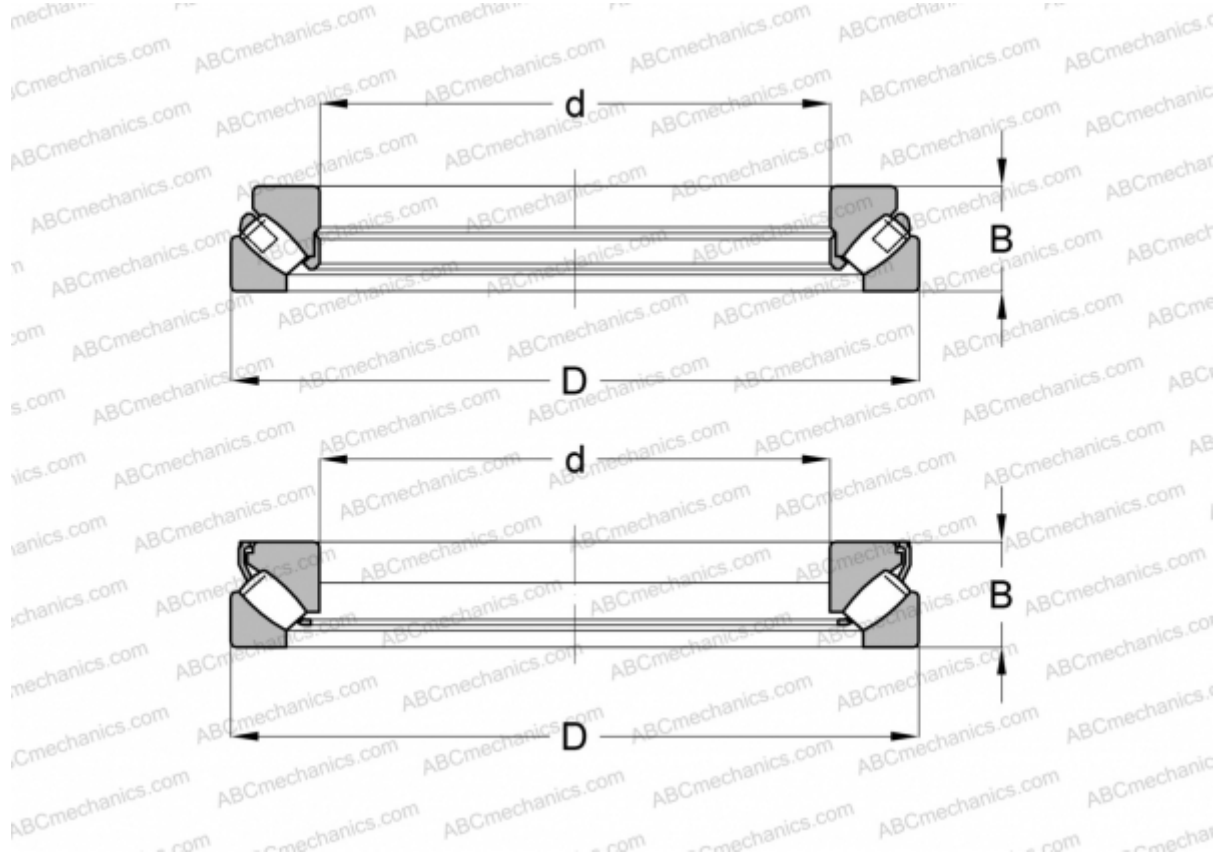

Technical specification

DIMENSIONS, MM

d	60,000
D	130,000
B	42,000

WEIGHT, KG 2,200

MANUFACTURER [SKF](#)

INTERCHANGE

ABC	29412E
FAG	29412 E

CALCULATION DATA

Basic dynamic load rating, C	390,000 kN
Basic static load rating, Co	915,000 kN
Fatigue load limit, Pu	114,000 kN
Reference speed	2800 r/min

CALCULATION DATA

Limiting speed	5000 r/min
----------------	------------