

29413E ABC

Spherical roller thrust bearings

TYPE: Roller bearings, Thrust roller bearing, Axial spherical

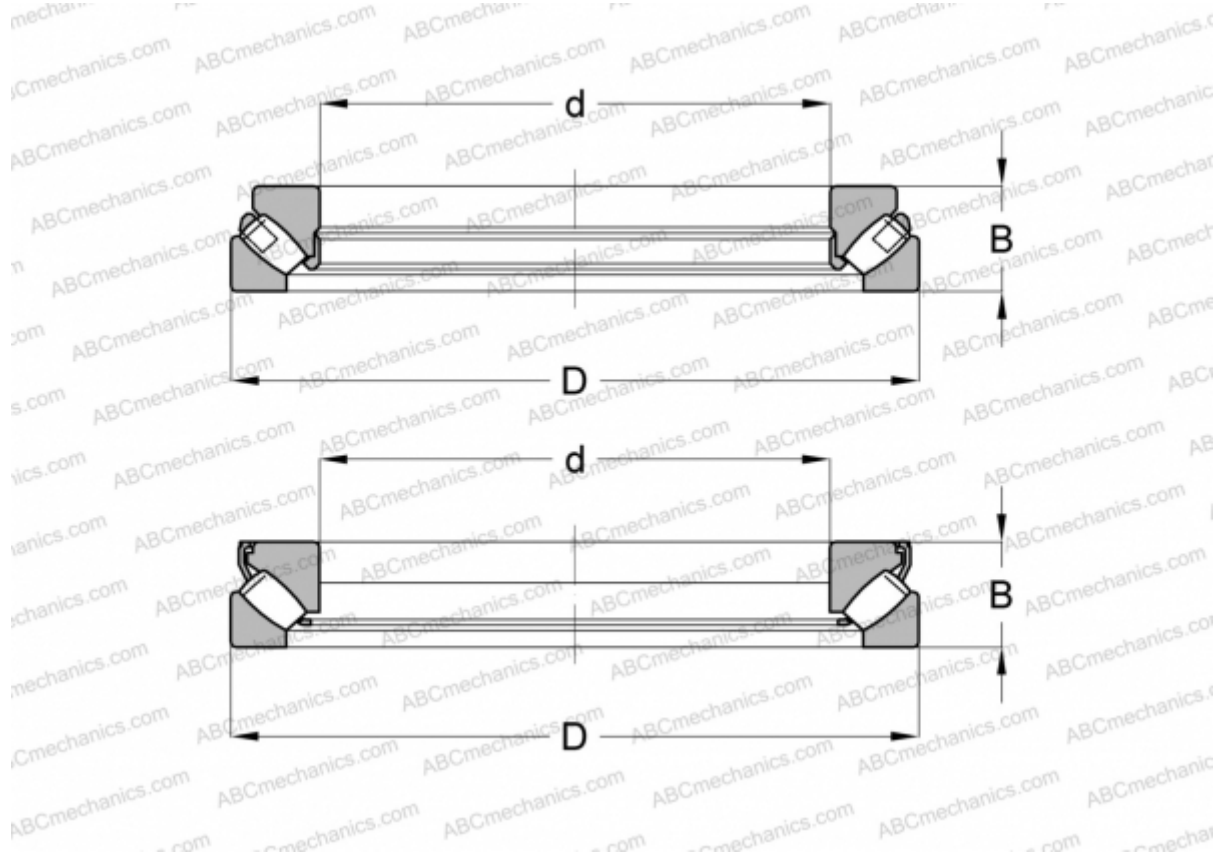

Technical specification

DIMENSIONS, MM

d	65,000
D	140,000
B	45,000

WEIGHT, KG 2,731

MANUFACTURER [ABC](#)

INTERCHANGE

FAG	29413 E
SKF	29413 E