

## 29413 E SKF

Spherical roller thrust bearings

TYPE: Roller bearings, Thrust roller bearing, Axial spherical

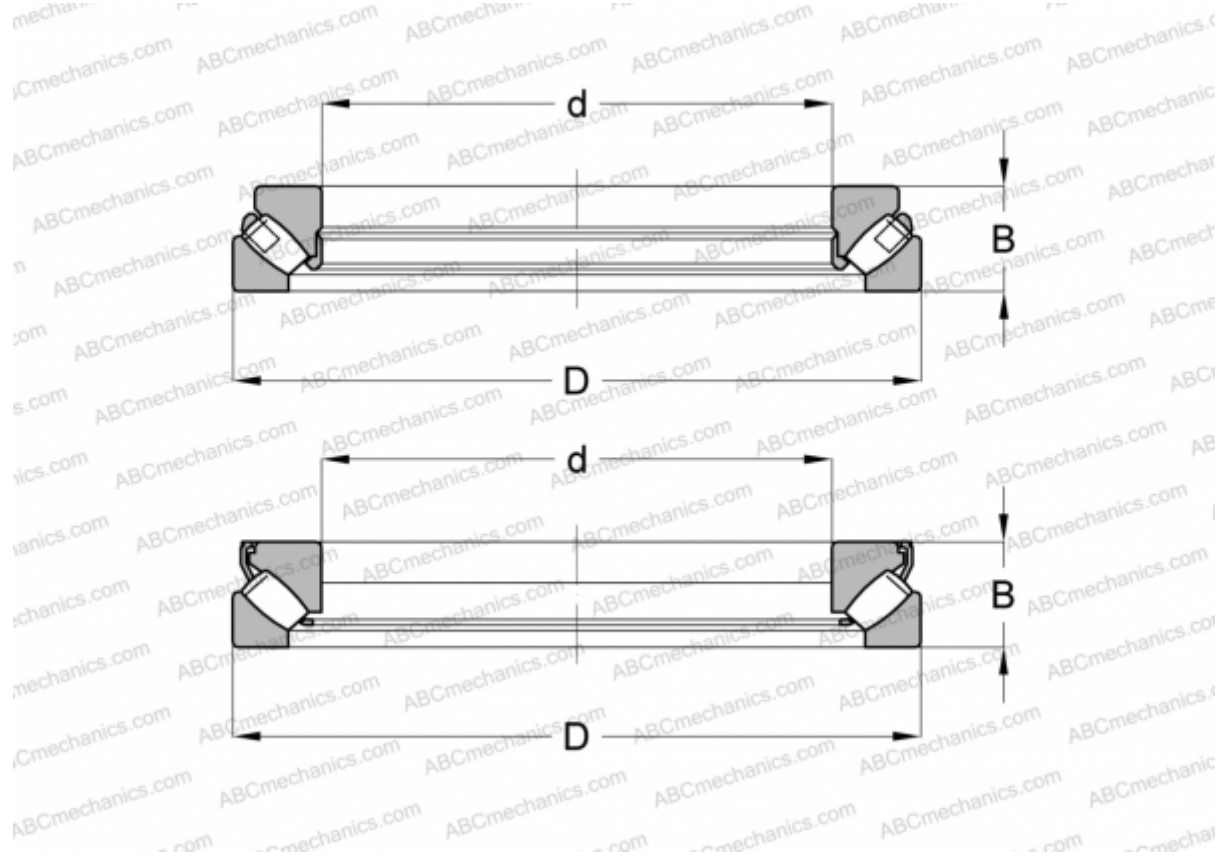

### Technical specification

#### DIMENSIONS, MM

d	65,000
D	140,000
B	45,000

**WEIGHT, KG** 3,200

**MANUFACTURER** [SKF](#)

#### INTERCHANGE

ABC	<a href="#">29413E</a>
FAG	<a href="#">29413 E</a>

#### CALCULATION DATA

Basic dynamic load rating, C	455,000 kN
Basic static load rating, Co	1080,000 kN
Fatigue load limit, Pu	137,000 kN
Reference speed	2600 r/min

#### CALCULATION DATA

Limiting speed	4800 r/min
----------------	------------