

29414 E SKF

Spherical roller thrust bearings

TYPE: Roller bearings, Thrust roller bearing, Axial spherical

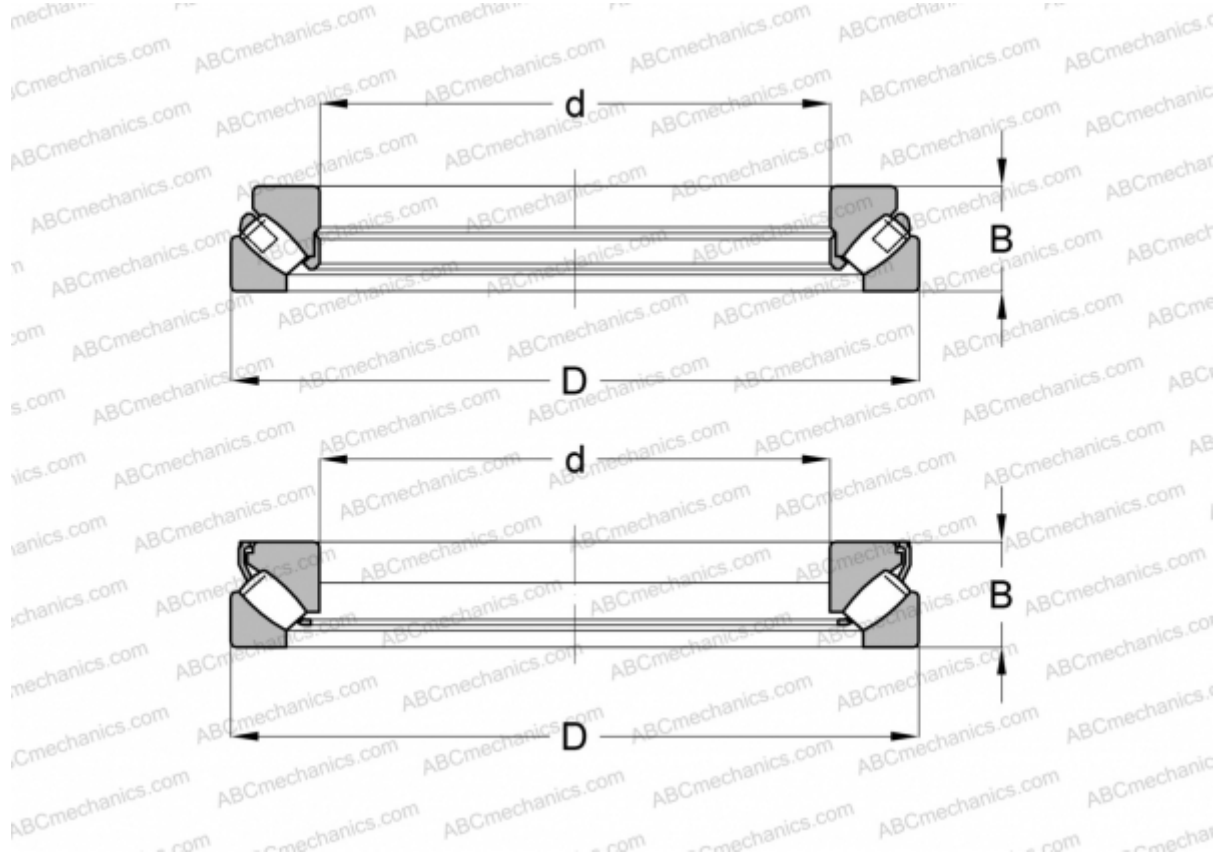

Technical specification

DIMENSIONS, MM

d	70,000
D	150,000
B	48,000

WEIGHT, KG 3,900

MANUFACTURER [SKF](#)

INTERCHANGE

ABC	29414E
FAG	29414 E

CALCULATION DATA

Basic dynamic load rating, C	520,000 kN
Basic static load rating, Co	1250,000 kN
Fatigue load limit, Pu	153,000 kN
Reference speed	2400 r/min

CALCULATION DATA

Limiting speed	4300 r/min
----------------	------------