

29415 E FAG

Spherical roller thrust bearings

TYPE: Roller bearings, Thrust roller bearing, Axial spherical

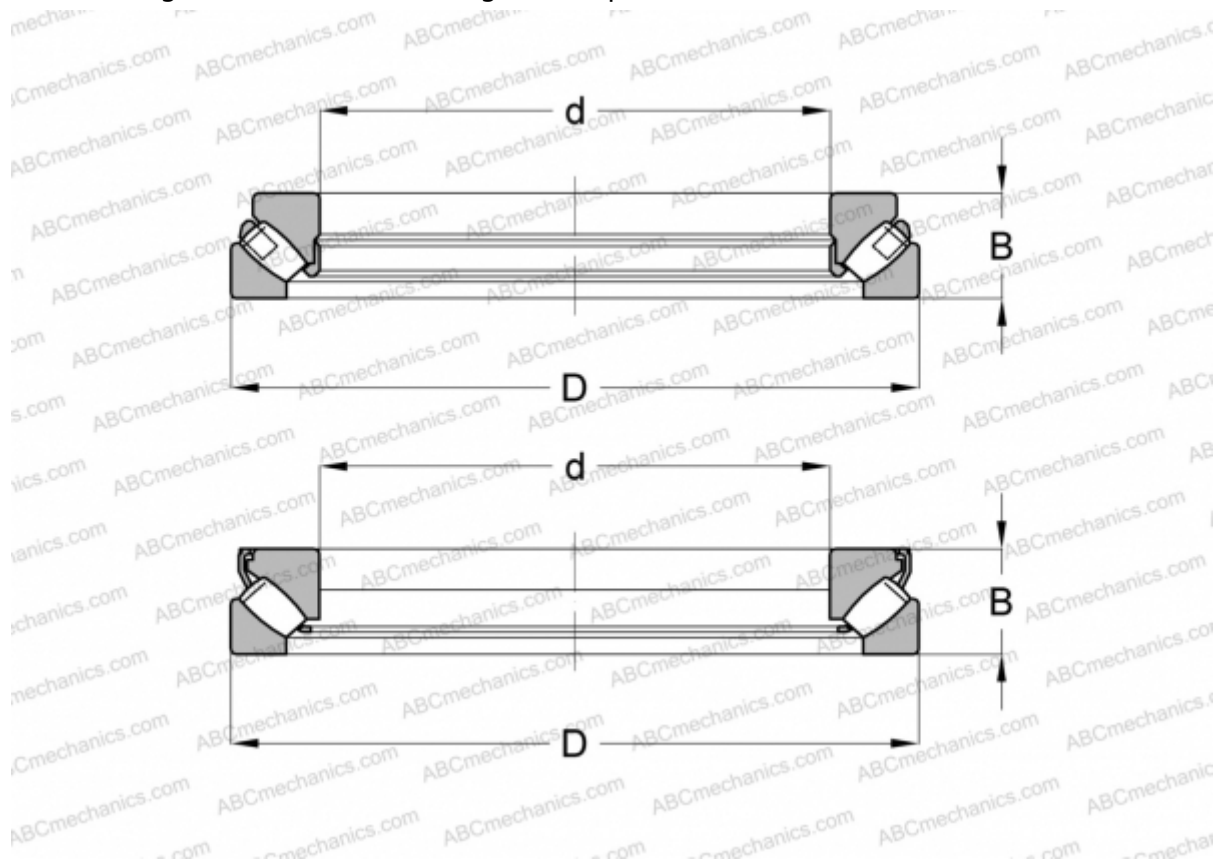

Technical specification

DIMENSIONS, MM

d	75,000
D	160,000
B	51,000

WEIGHT, KG 4,277

MANUFACTURER [FAG](#)

INTERCHANGE

ABC	29415E
SKF	29415 E