

## 29415 E SKF

Spherical roller thrust bearings

TYPE: Roller bearings, Thrust roller bearing, Axial spherical

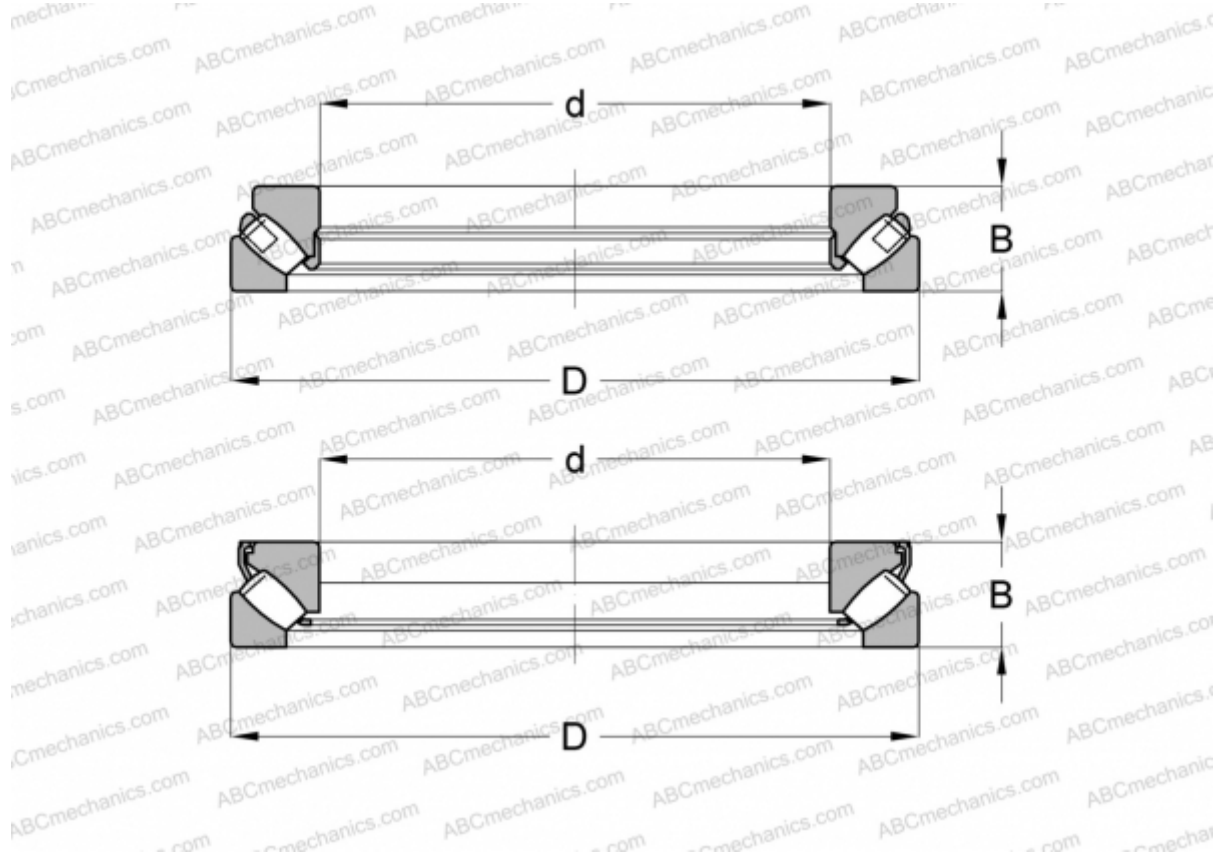

### Technical specification

#### DIMENSIONS, MM

d	75,000
D	160,000
B	51,000

**WEIGHT, KG** 4,700

**MANUFACTURER** [SKF](#)

#### INTERCHANGE

ABC	<a href="#">29415E</a>
FAG	<a href="#">29415 E</a>

#### CALCULATION DATA

Basic dynamic load rating, C	600,000 kN
Basic static load rating, Co	1430,000 kN
Fatigue load limit, Pu	173,000 kN
Reference speed	2400 r/min

#### CALCULATION DATA

Limiting speed	4000 r/min
----------------	------------