

29416E ABC

Spherical roller thrust bearings

TYPE: Roller bearings, Thrust roller bearing, Axial spherical

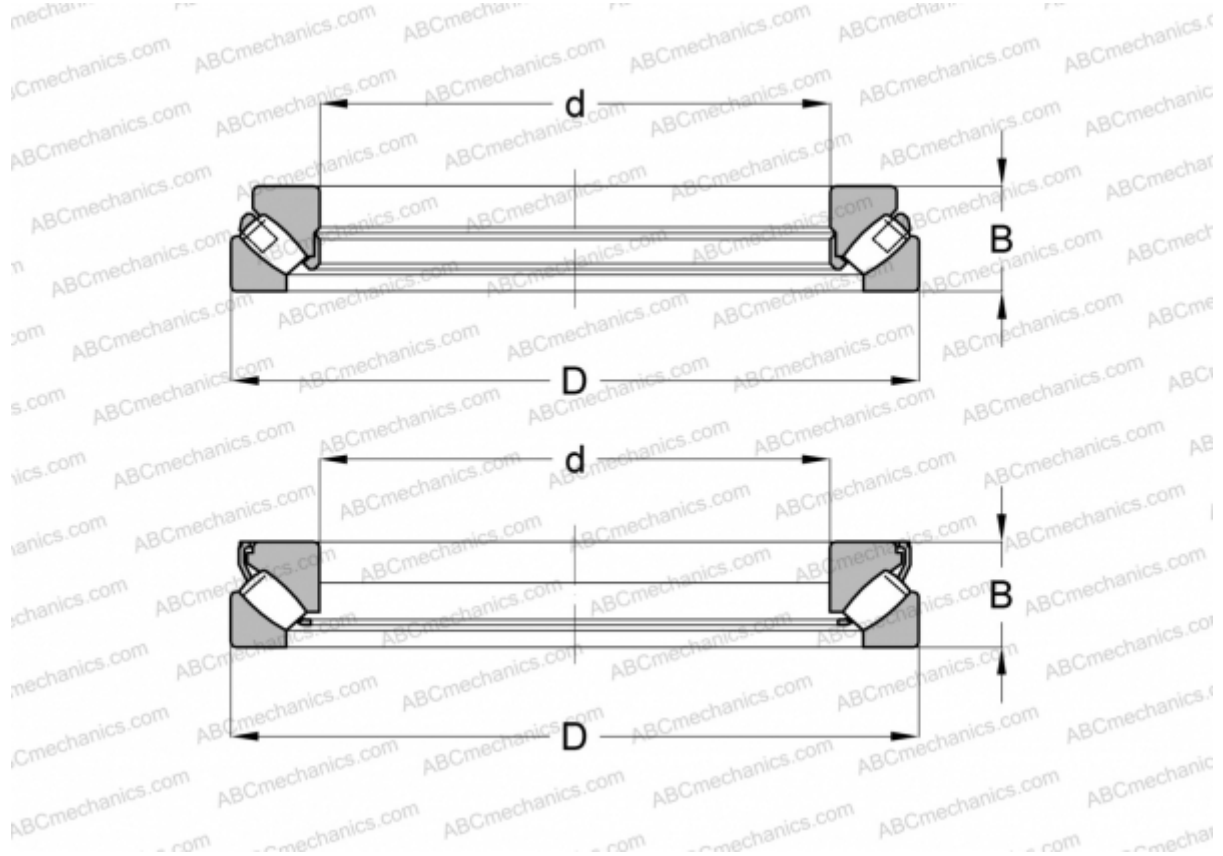

Technical specification

DIMENSIONS, MM

d	80,000
D	170,000
B	54,000

WEIGHT, KG 5,171

MANUFACTURER [ABC](#)

INTERCHANGE

FAG	29416 E
SKF	29416 E