

29416 E FAG

Spherical roller thrust bearings

TYPE: Roller bearings, Thrust roller bearing, Axial spherical

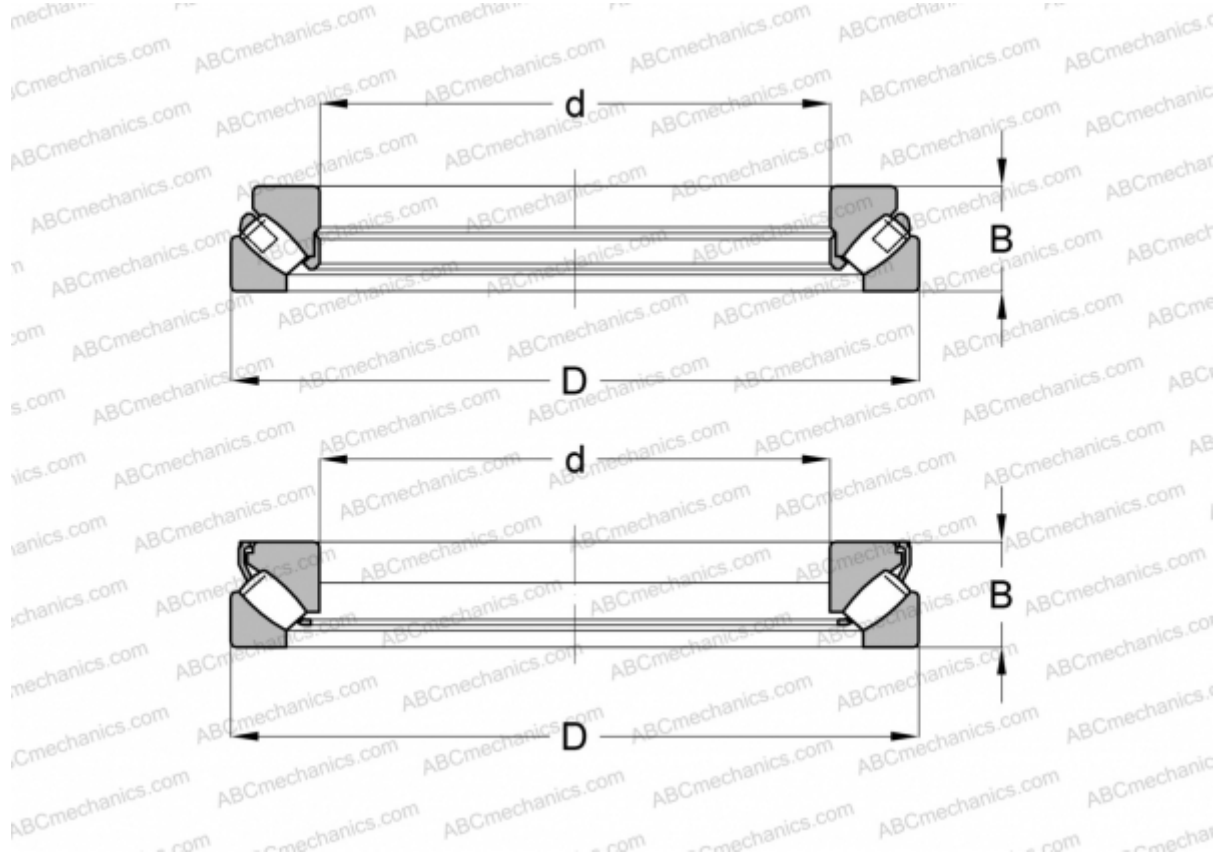

Technical specification

DIMENSIONS, MM

d	80,000
D	170,000
B	54,000

WEIGHT, KG 5,171

MANUFACTURER [FAG](#)

INTERCHANGE

ABC	29416E
SKF	29416 E