

## 29416 E SKF

Spherical roller thrust bearings

TYPE: Roller bearings, Thrust roller bearing, Axial spherical

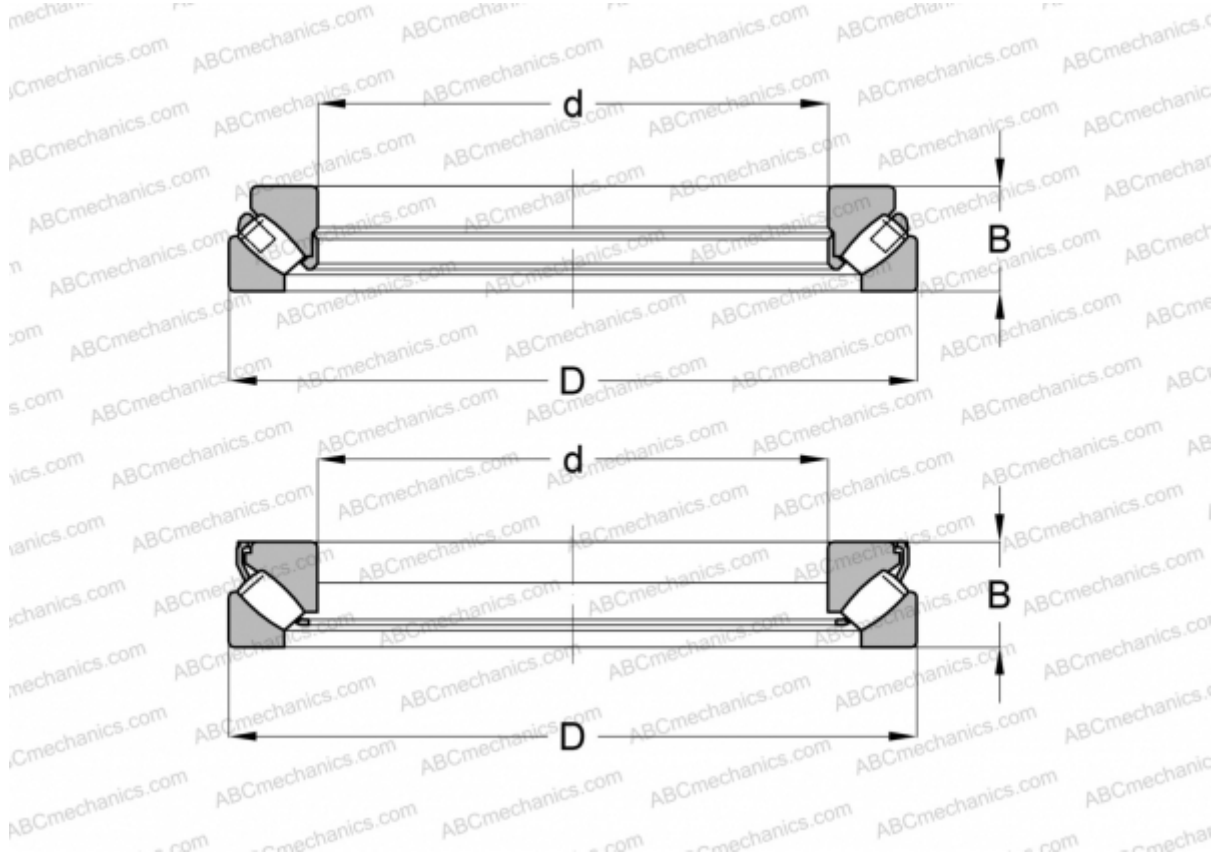

### Technical specification

#### DIMENSIONS, MM

d	80,000
D	170,000
B	54,000

**WEIGHT, KG** 5,600

**MANUFACTURER** [SKF](#)

#### INTERCHANGE

ABC	<a href="#">29416E</a>
FAG	<a href="#">29416 E</a>

#### CALCULATION DATA

Basic dynamic load rating, C	670,000 kN
Basic static load rating, Co	1630,000 kN
Fatigue load limit, Pu	193,000 kN
Reference speed	2200 r/min

#### CALCULATION DATA

Limiting speed	3800 r/min
----------------	------------