

29317E ABC

Spherical roller thrust bearings

TYPE: Roller bearings, Thrust roller bearing, Axial spherical

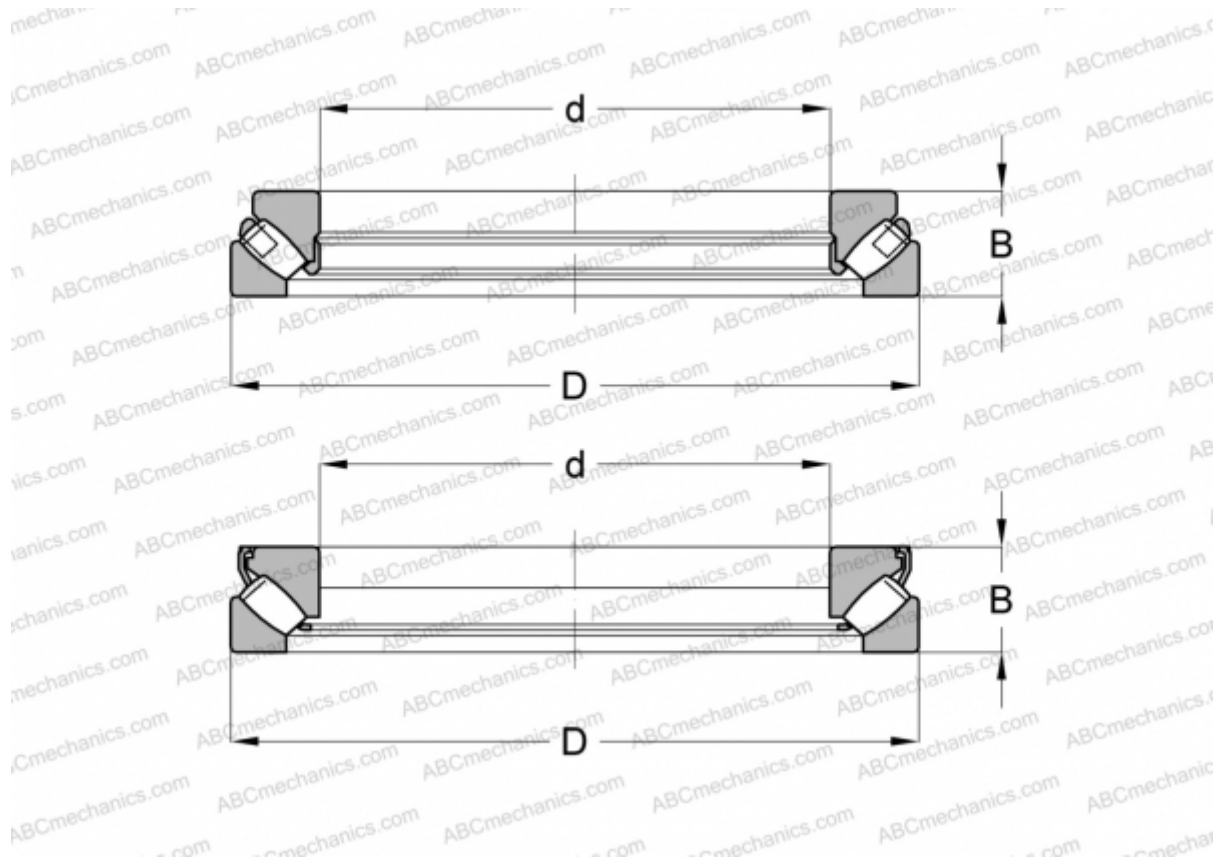

Technical specification

DIMENSIONS, MM

d	85,000
D	150,000
B	39,000

WEIGHT, KG 2,495

MANUFACTURER [ABC](#)

INTERCHANGE

FAG	29317 E
SKF	29317 E