

29317 E SKF

Spherical roller thrust bearings

TYPE: Roller bearings, Thrust roller bearing, Axial spherical

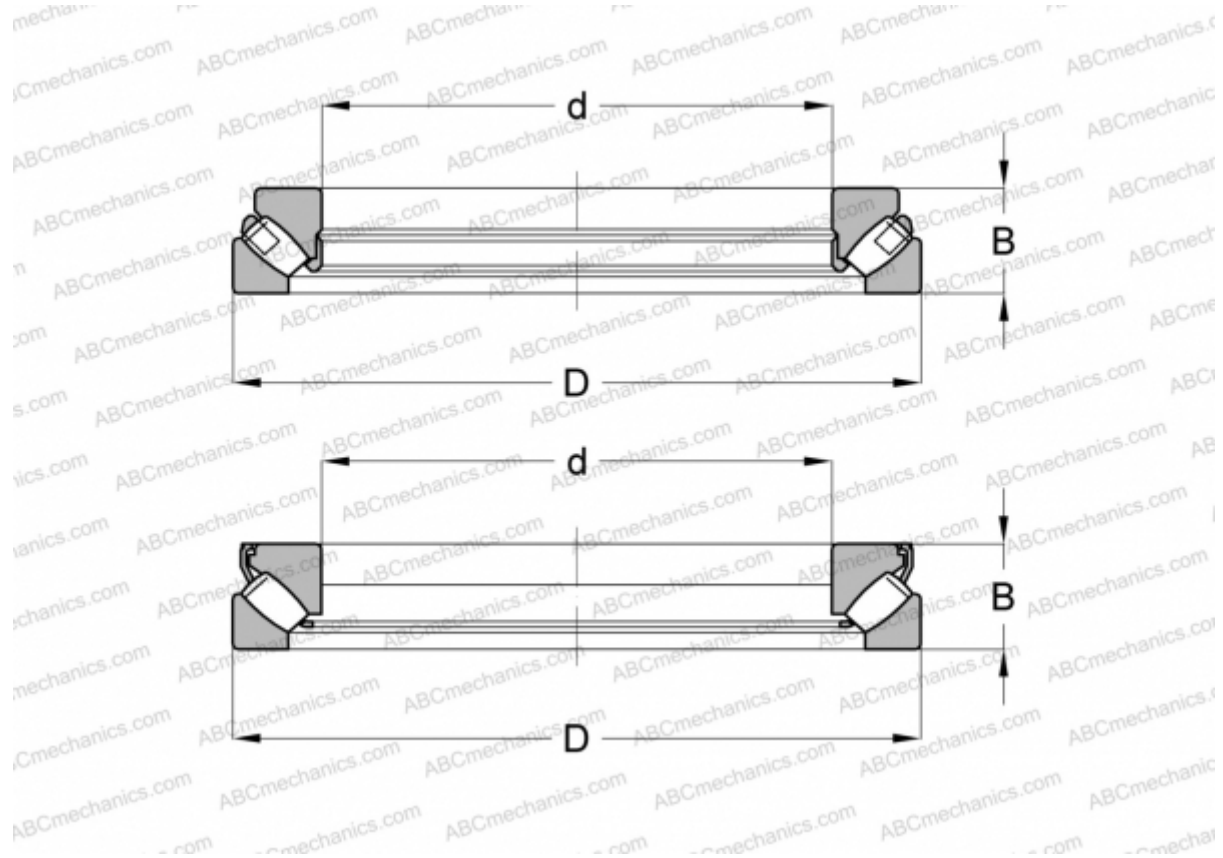

Technical specification

DIMENSIONS, MM

d	85,000
D	150,000
B	39,000

WEIGHT, KG 2,750

MANUFACTURER [SKF](#)

INTERCHANGE

ABC	29317E
FAG	29317 E

CALCULATION DATA

Limiting speed	4000 r/min
----------------	------------

CALCULATION DATA

Basic dynamic load rating, C	380,000 kN
Basic static load rating, Co	1060,000 kN
Fatigue load limit, Pu	129,000 kN
Reference speed	2400 r/min