

29417E ABC

Spherical roller thrust bearings

TYPE: Roller bearings, Thrust roller bearing, Axial spherical

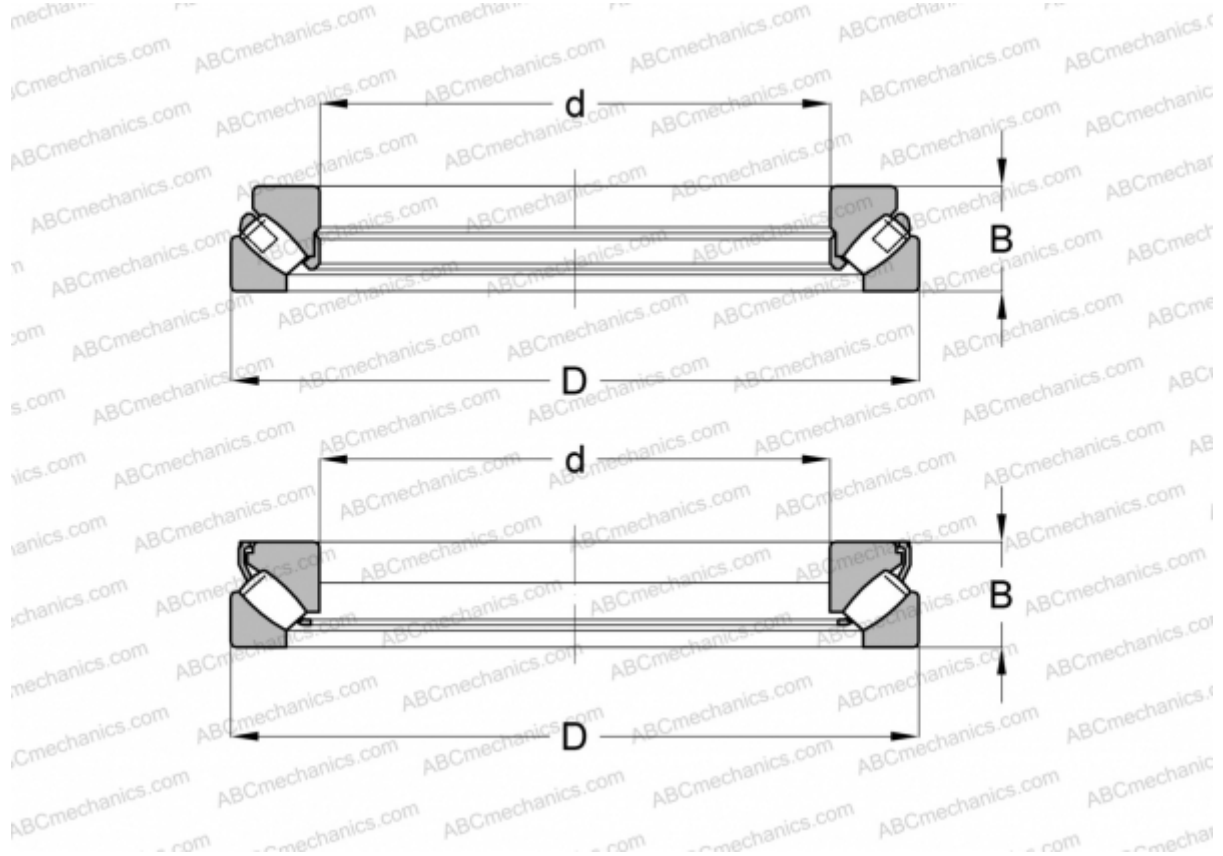

Technical specification

DIMENSIONS, MM

d	85,000
D	180,000
B	58,000

WEIGHT, KG 6,260

MANUFACTURER [ABC](#)

INTERCHANGE

FAG	29417 E
SKF	29417 E