

29318 E SKF

Spherical roller thrust bearings

TYPE: Roller bearings, Thrust roller bearing, Axial spherical

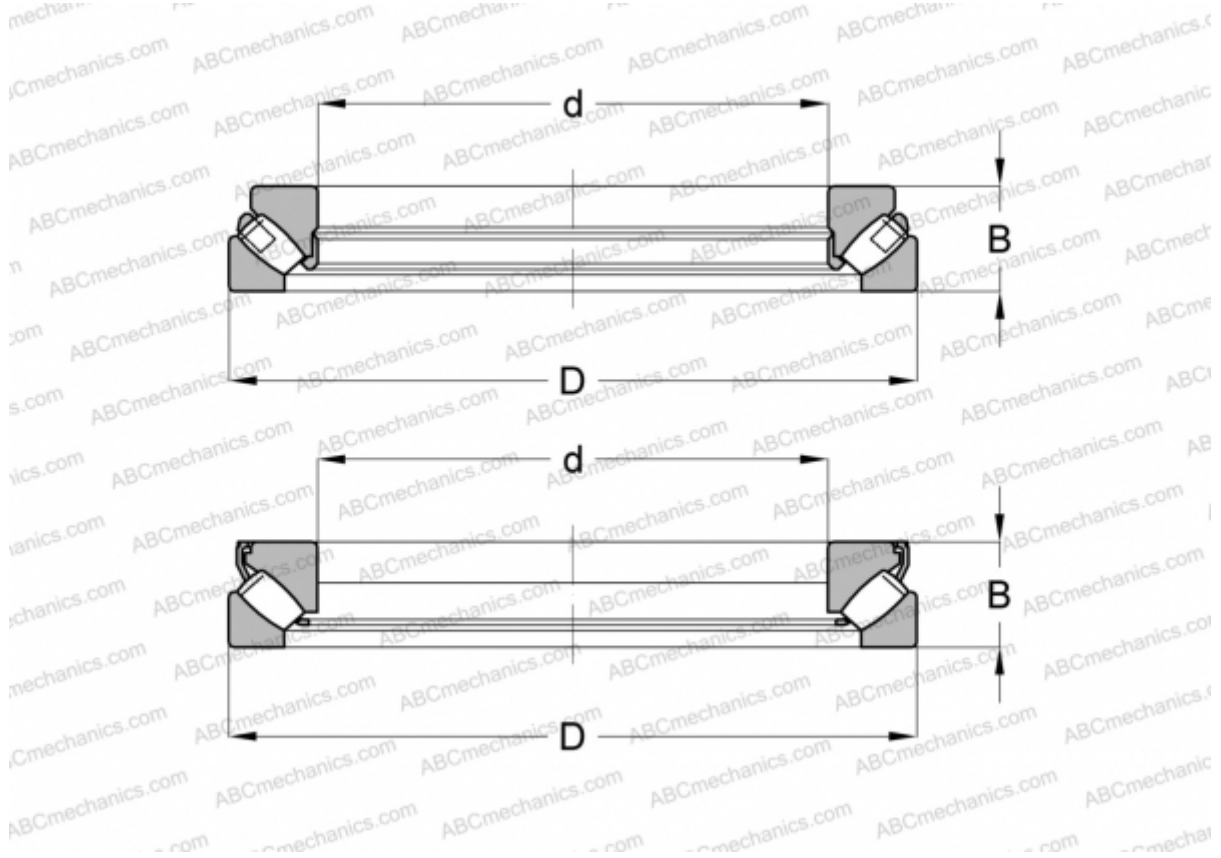

Technical specification

DIMENSIONS, MM

d	90,000
D	155,000
B	39,000

CALCULATION DATA

Limiting speed	4000 r/min
----------------	------------

WEIGHT, KG 2,850

MANUFACTURER [SKF](#)

INTERCHANGE

ABC	29318E
FAG	29318 E

CALCULATION DATA

Basic dynamic load rating, C	400,000 kN
Basic static load rating, Co	1080,000 kN
Fatigue load limit, Pu	132,000 kN
Reference speed	2400 r/min