

29320 E SKF

Spherical roller thrust bearings

TYPE: Roller bearings, Thrust roller bearing, Axial spherical

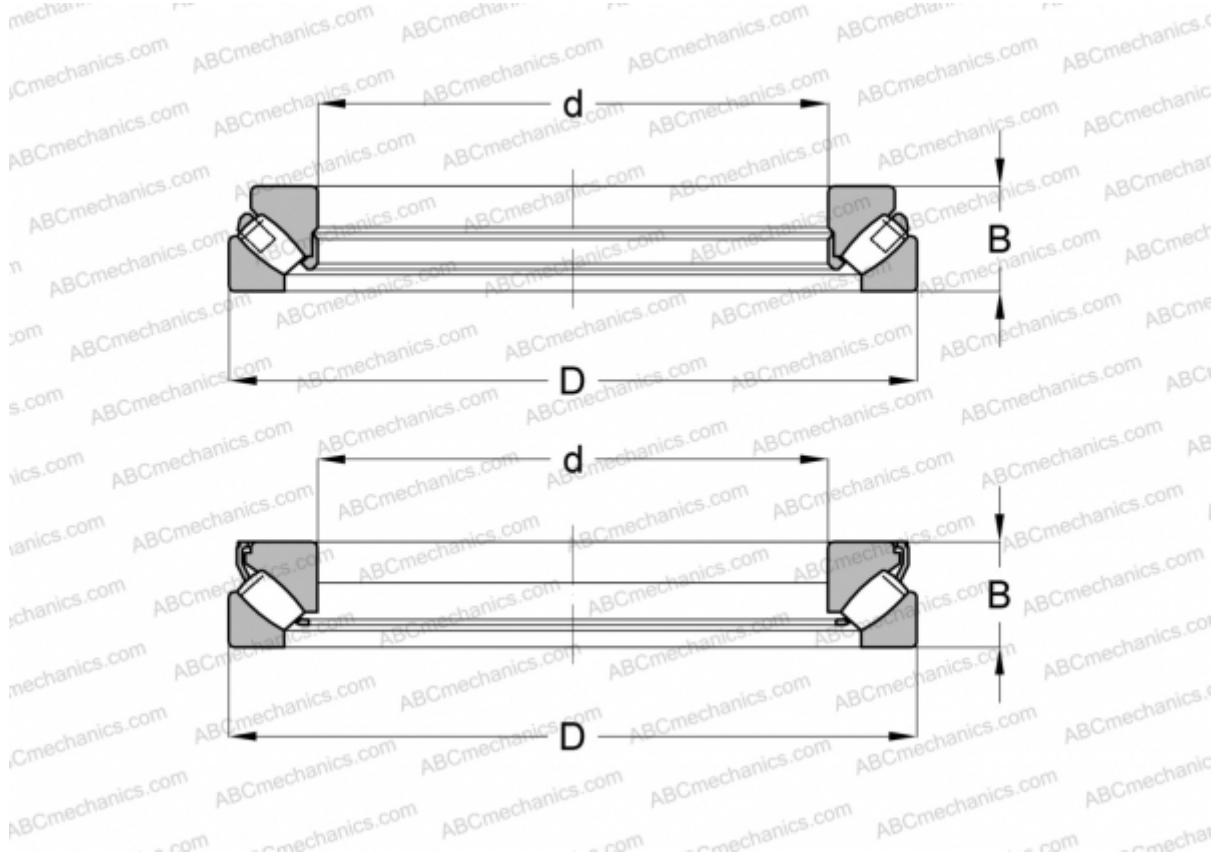

Technical specification

DIMENSIONS, MM

d	100,000
D	170,000
B	42,000

WEIGHT, KG 3,650

MANUFACTURER [SKF](#)

INTERCHANGE

ABC	29320E
FAG	29320 E

CALCULATION DATA

Basic dynamic load rating, C	465,000 kN
Basic static load rating, Co	1290,000 kN
Fatigue load limit, Pu	156,000 kN
Reference speed	2200 r/min

CALCULATION DATA

Limiting speed	3600 r/min
----------------	------------