

29420 E FAG

Spherical roller thrust bearings

TYPE: Roller bearings, Thrust roller bearing, Axial spherical

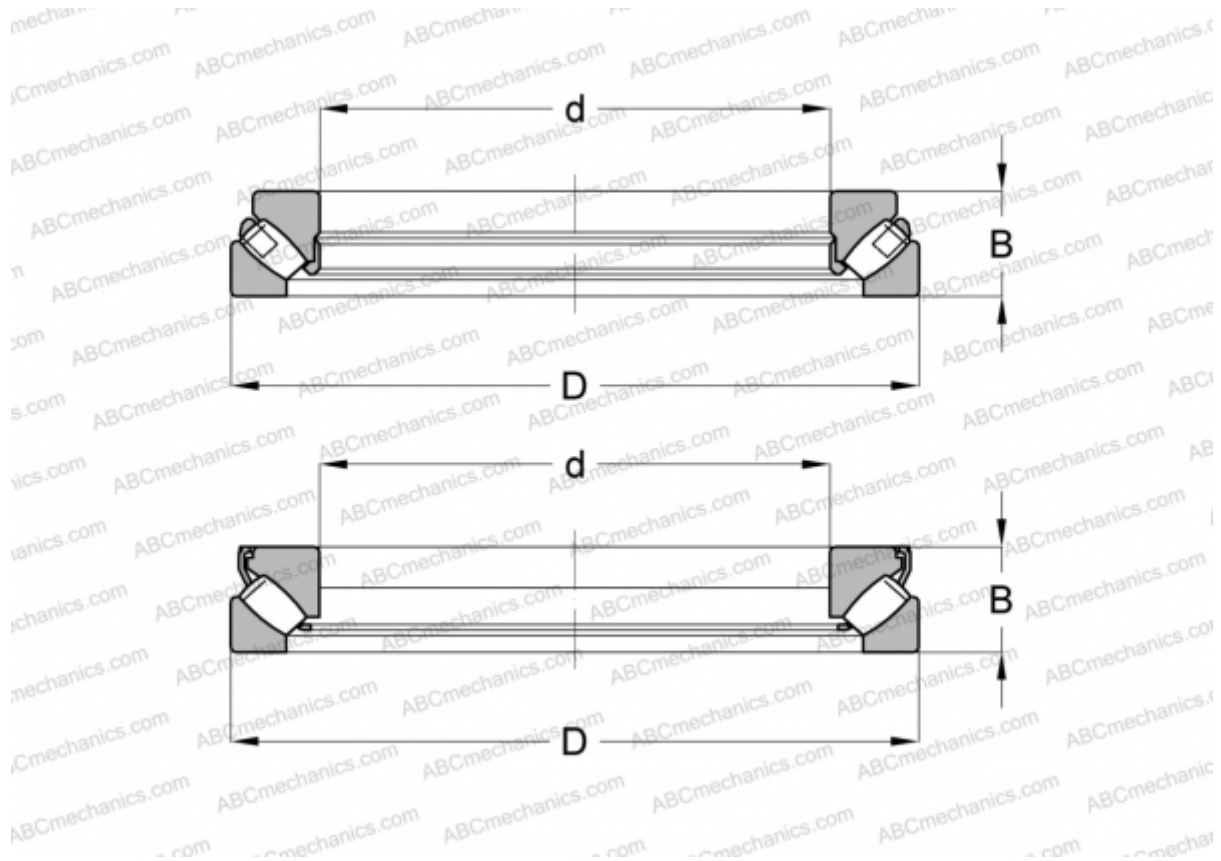

Technical specification

DIMENSIONS, MM

d	100,000
D	210,000
B	67,000

WEIGHT, KG 9,843

MANUFACTURER [FAG](#)

INTERCHANGE

ABC	29420E
SKF	29420 E