

29322E ABC

Spherical roller thrust bearings

TYPE: Roller bearings, Thrust roller bearing, Axial spherical

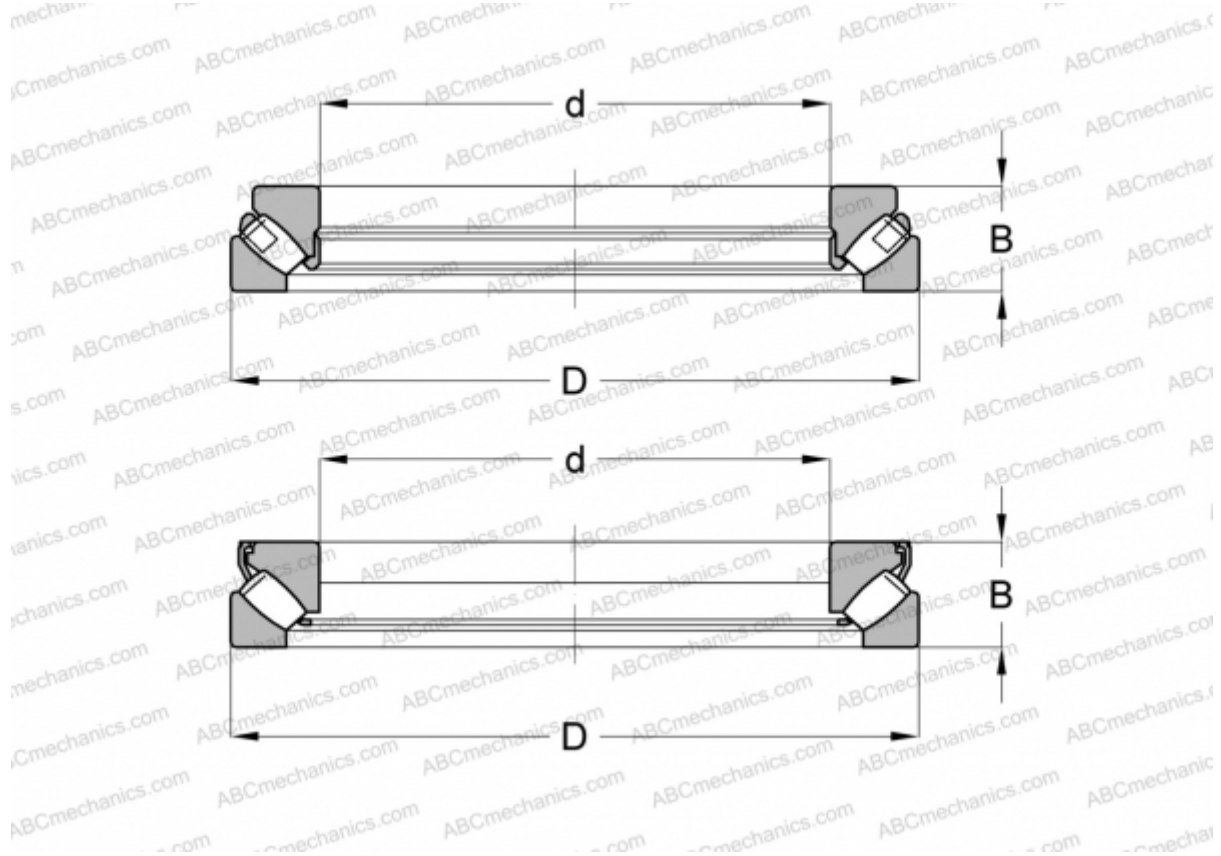

Technical specification

DIMENSIONS, MM

d	110,000
D	190,000
B	48,000

WEIGHT, KG 4,990

MANUFACTURER [ABC](#)

INTERCHANGE

FAG	29322 E
SKF	29322 E