

29322 E SKF

Spherical roller thrust bearings

TYPE: Roller bearings, Thrust roller bearing, Axial spherical

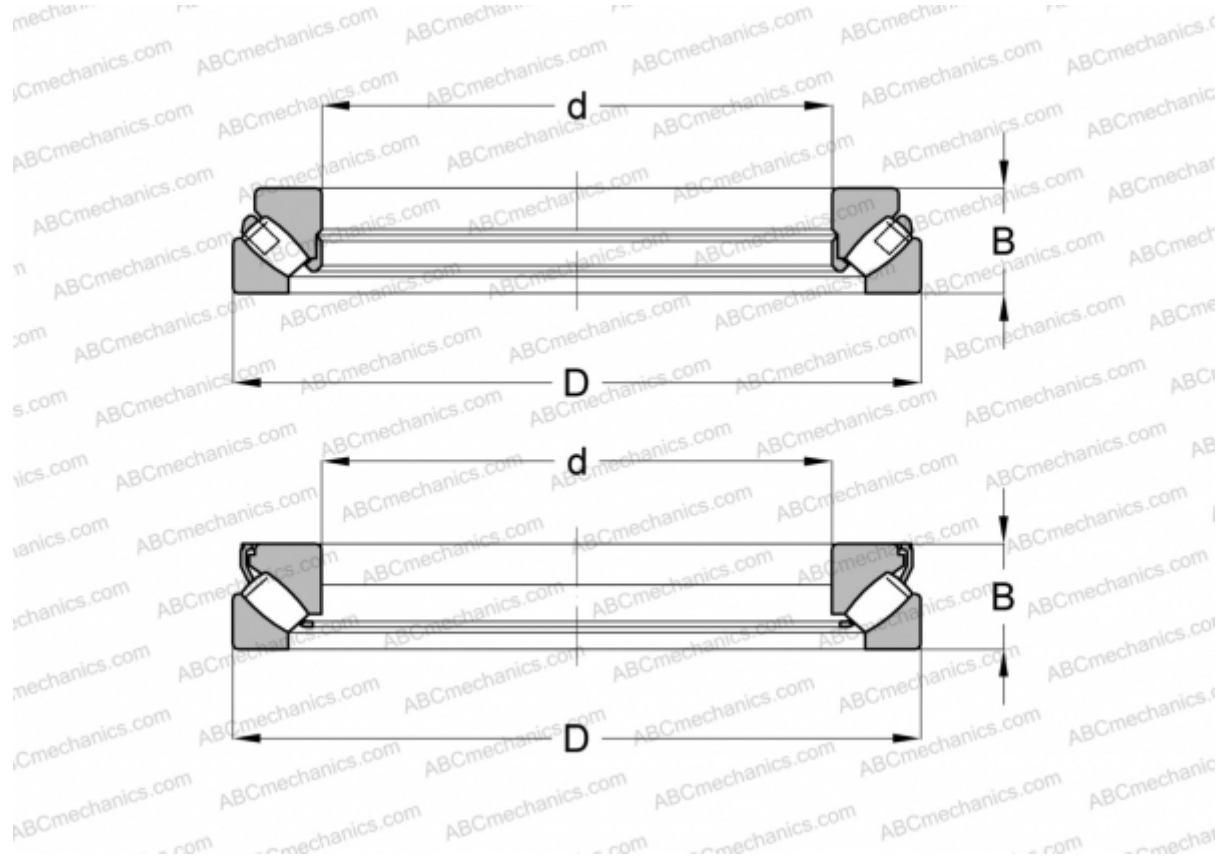

Technical specification

DIMENSIONS, MM

d	110,000
D	190,000
B	48,000

WEIGHT, KG 5,300

MANUFACTURER [SKF](#)

INTERCHANGE

ABC	29322E
FAG	29322 E

CALCULATION DATA

Basic dynamic load rating, C	610,000 kN
Basic static load rating, Co	1730,000 kN
Fatigue load limit, Pu	204,000 kN
Reference speed	1900 r/min

CALCULATION DATA

Limiting speed	3200 r/min
----------------	------------