

29422 TORRINGTON

Spherical roller thrust bearings

TYPE: Roller bearings, Thrust roller bearing, Axial spherical

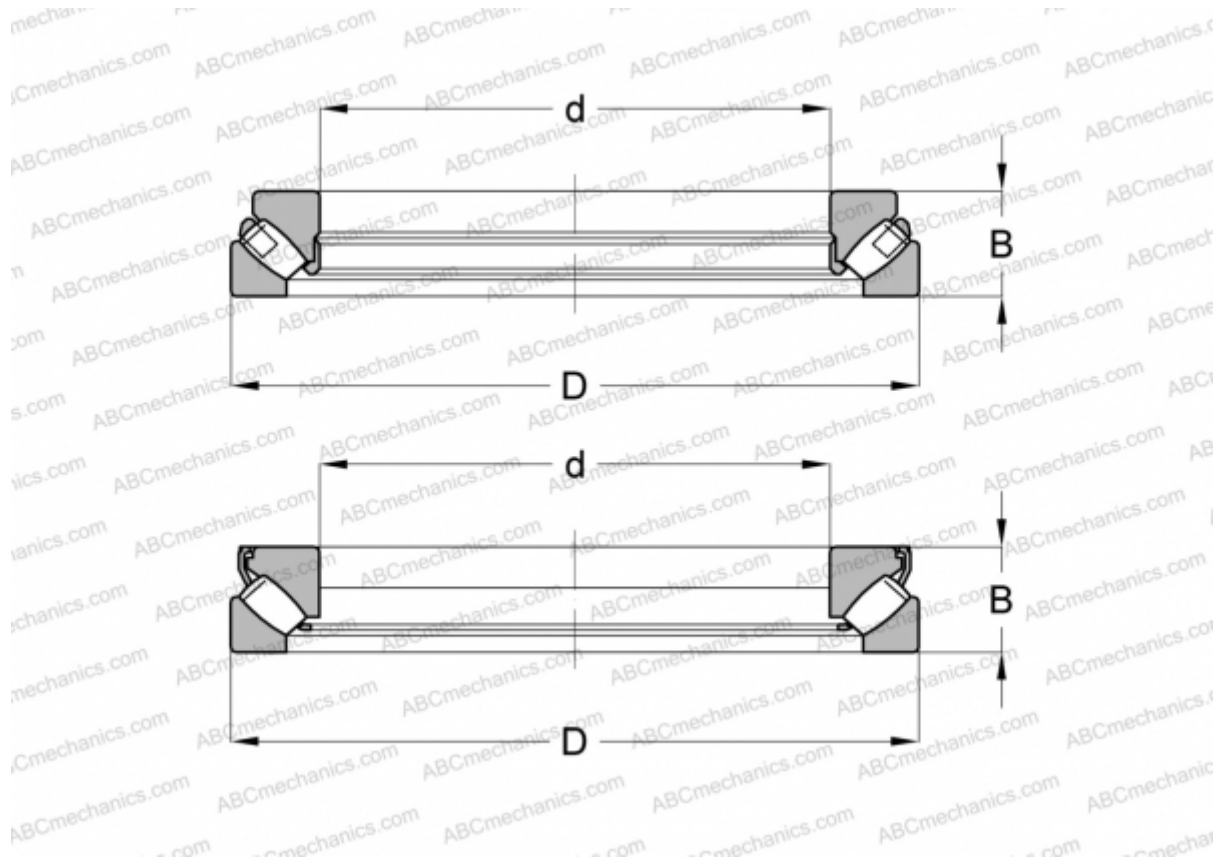

Technical specification

DIMENSIONS, MM

d	110,000
D	230,000
B	73,000

WEIGHT, KG 12,837

MANUFACTURER [TORRINGTON](#)

INTERCHANGE

ABC	29422E
FAG	29422 E
SKF	29422 E