

29326 E FAG

Spherical roller thrust bearings

TYPE: Roller bearings, Thrust roller bearing, Axial spherical

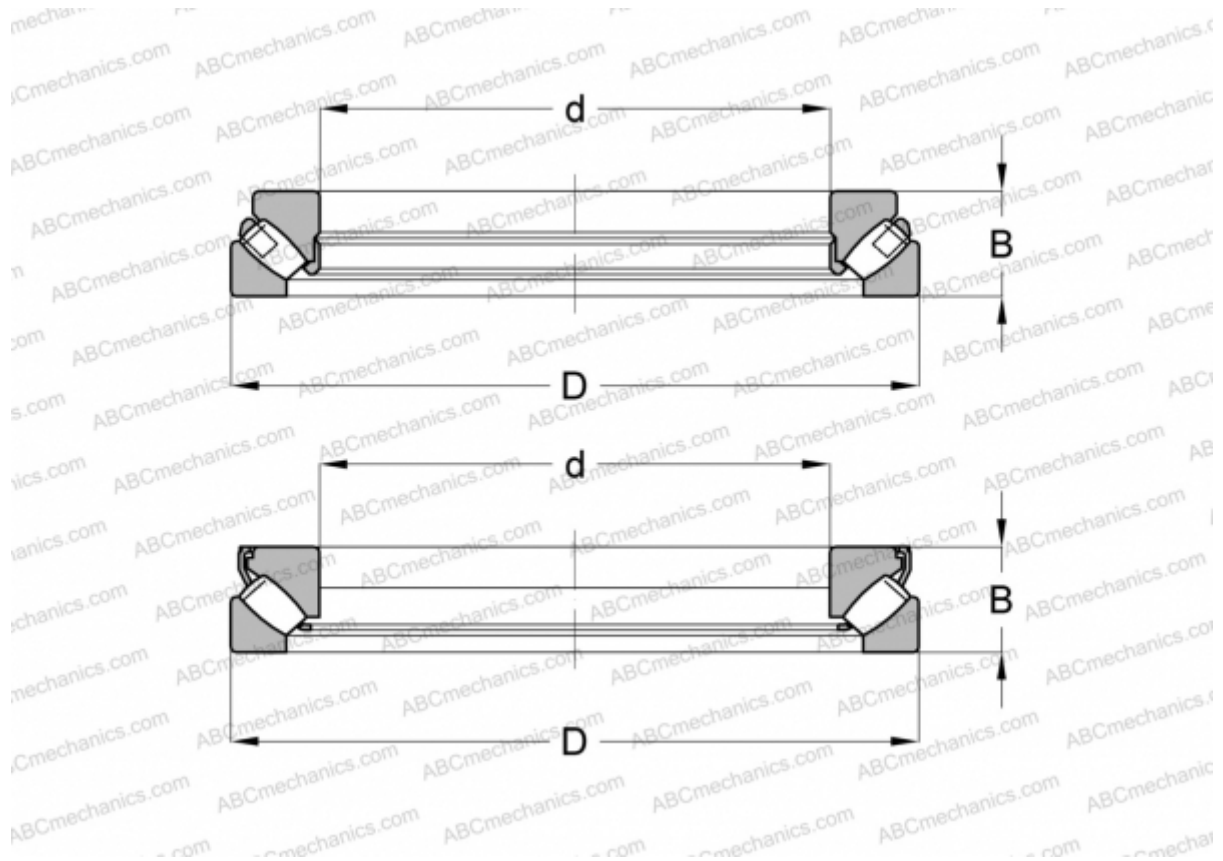

Technical specification

DIMENSIONS, MM

d	130,000
D	225,000
B	58,000

WEIGHT, KG 8,346

MANUFACTURER [FAG](#)

INTERCHANGE

ABC	29326E
SKF	29326 E
TORRINGTON	29326