

## 29326 TORRINGTON

Spherical roller thrust bearings

TYPE: Roller bearings, Thrust roller bearing, Axial spherical

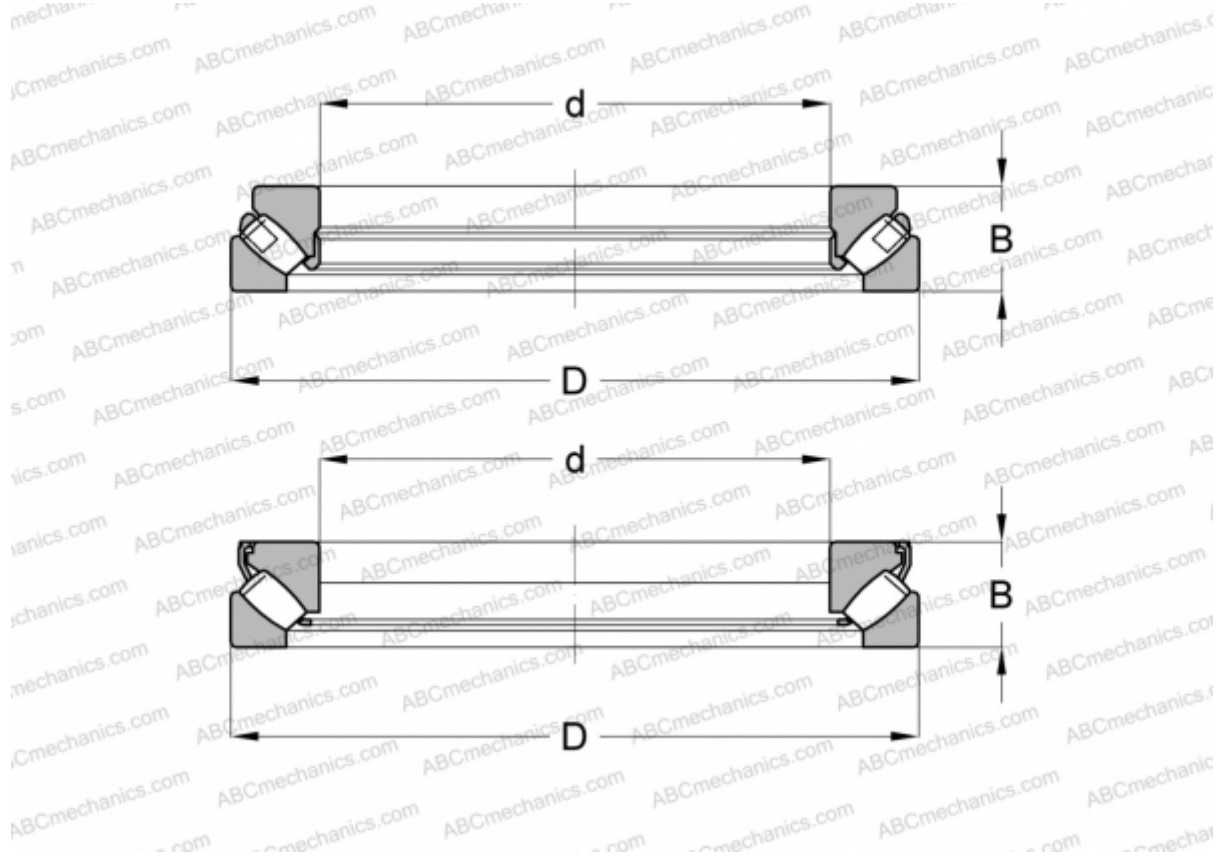

### Technical specification

#### DIMENSIONS, MM

d	130,000
D	225,000
B	58,000

**WEIGHT, KG** 8,346

**MANUFACTURER** [TORRINGTON](#)

#### INTERCHANGE

ABC	<a href="#">29326E</a>
FAG	<a href="#">29326 E</a>
SKF	<a href="#">29326 E</a>