

29426 E SKF

Spherical roller thrust bearings

TYPE: Roller bearings, Thrust roller bearing, Axial spherical

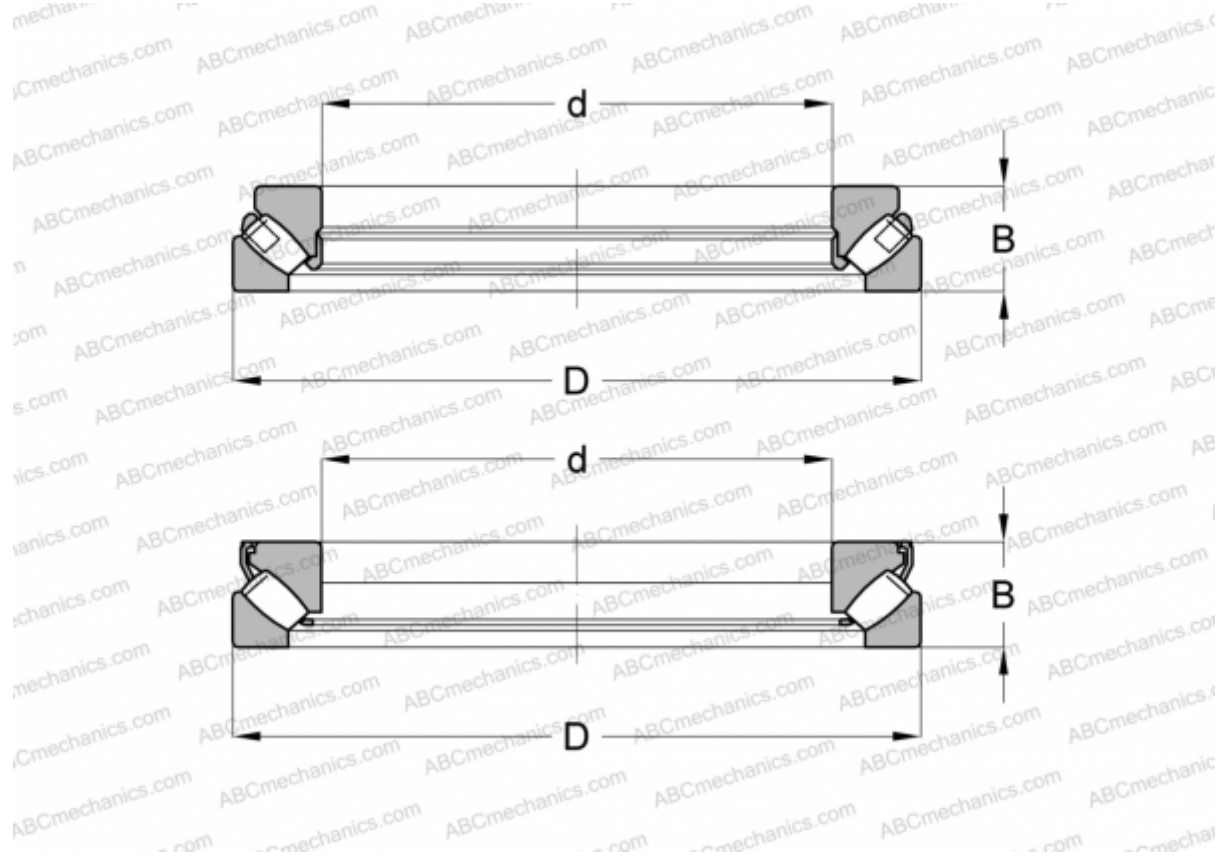

Technical specification

DIMENSIONS, MM

d	130,000
D	270,000
B	85,000

WEIGHT, KG 22,000

MANUFACTURER [SKF](#)

INTERCHANGE

ABC	29426E
FAG	29426 E
TORRINGTON	29426

CALCULATION DATA

Basic dynamic load rating, C	1560,000 kN
Basic static load rating, Co	4050,000 kN
Fatigue load limit, Pu	430,000 kN

CALCULATION DATA

Reference speed	1300 r/min
Limiting speed	2400 r/min