

29426 TORRINGTON

Spherical roller thrust bearings

TYPE: Roller bearings, Thrust roller bearing, Axial spherical

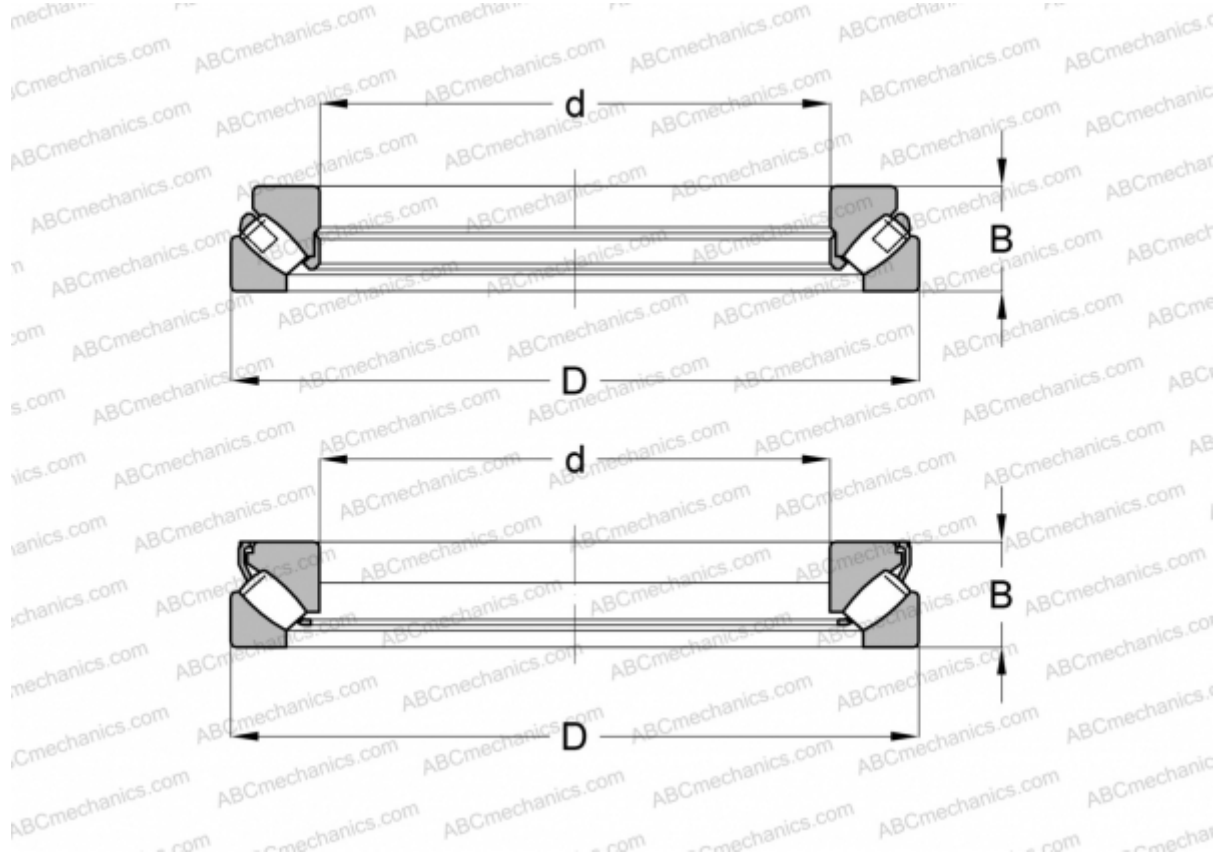

Technical specification

DIMENSIONS, MM

d	130,000
D	270,000
B	85,000

WEIGHT, KG 20,185

MANUFACTURER [TORRINGTON](#)

INTERCHANGE

ABC	29426E
FAG	29426 E
SKF	29426 E