

29328 E SKF

Spherical roller thrust bearings

TYPE: Roller bearings, Thrust roller bearing, Axial spherical

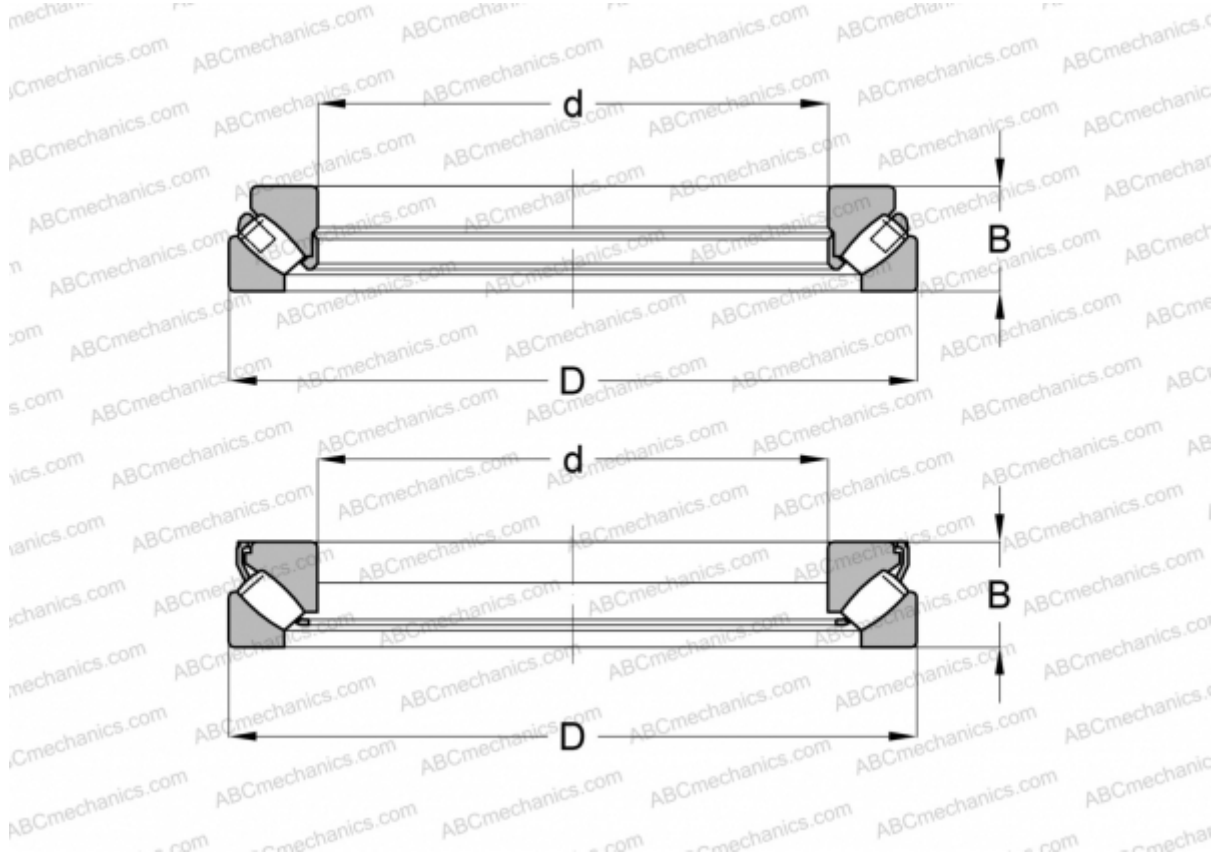

Technical specification

DIMENSIONS, MM

d	140,000
D	240,000
B	60,000

WEIGHT, KG 10,500

MANUFACTURER [SKF](#)

INTERCHANGE

ABC	29328E
FAG	29328 E

CALCULATION DATA

Basic dynamic load rating, C	980,000 kN
Basic static load rating, Co	2850,000 kN
Fatigue load limit, Pu	315,000 kN
Reference speed	1500 r/min

CALCULATION DATA

Limiting speed	2600 r/min
----------------	------------