

29330E ABC

Spherical roller thrust bearings

TYPE: Roller bearings, Thrust roller bearing, Axial spherical

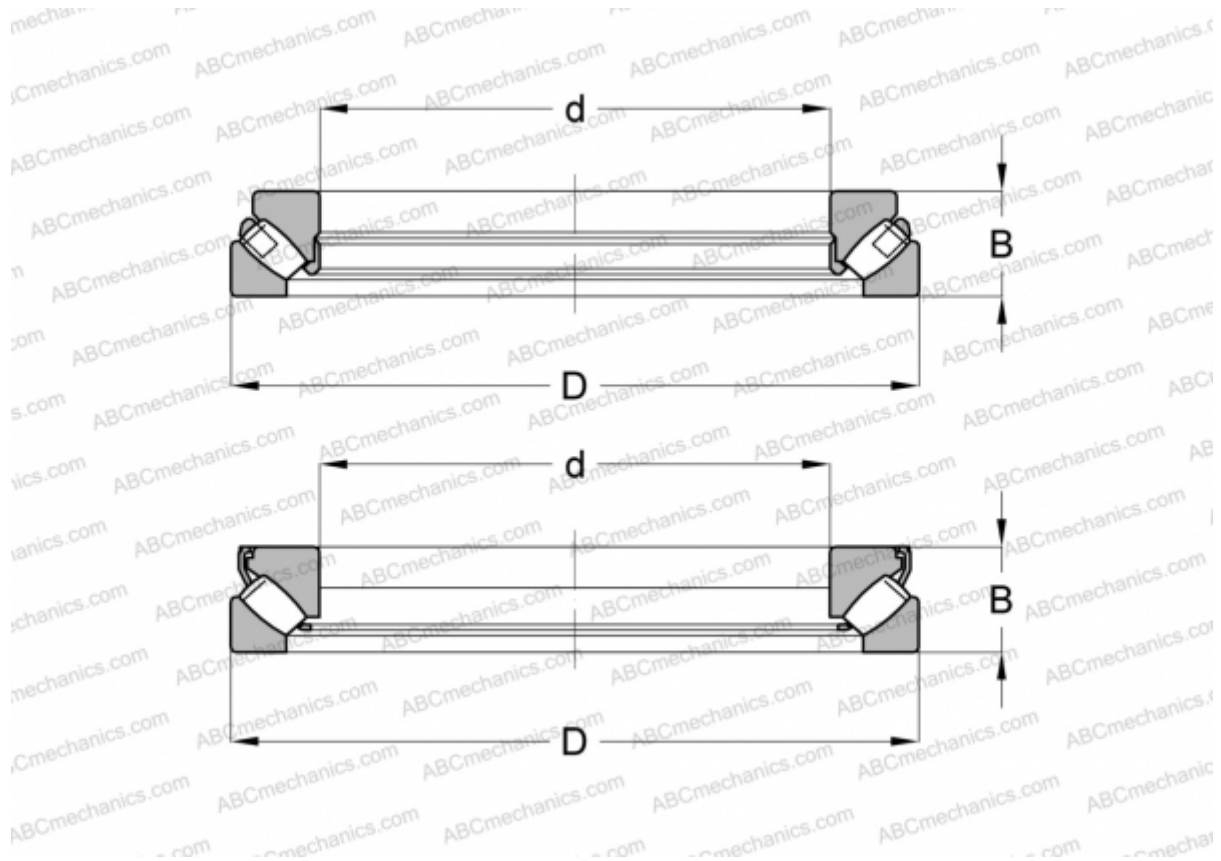

Technical specification

DIMENSIONS, MM

d	150,000
D	250,000
B	60,000

WEIGHT, KG 10,297

MANUFACTURER [ABC](#)

INTERCHANGE

FAG	29330 E
SKF	29330 E
TORRINGTON	29330