

29330 E SKF

Spherical roller thrust bearings

TYPE: Roller bearings, Thrust roller bearing, Axial spherical

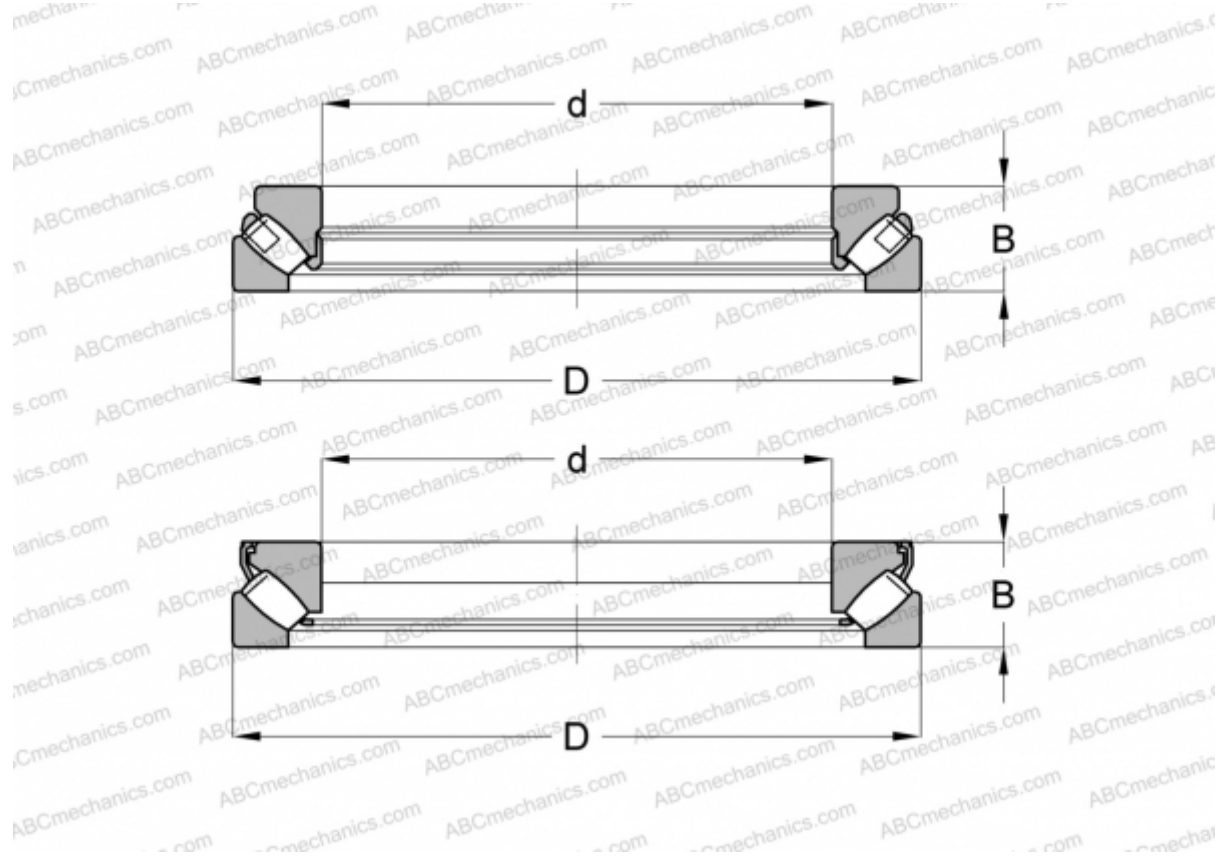

Technical specification

DIMENSIONS, MM

d	150,000
D	250,000
B	60,000

WEIGHT, KG 11,000

MANUFACTURER [SKF](#)

INTERCHANGE

ABC	29330E
FAG	29330 E
TORRINGTON	29330

CALCULATION DATA

Basic dynamic load rating, C	1000,000 kN
Basic static load rating, Co	2850,000 kN
Fatigue load limit, Pu	315,000 kN

CALCULATION DATA

Reference speed	1500 r/min
Limiting speed	2400 r/min