

29430E ABC

Spherical roller thrust bearings

TYPE: Roller bearings, Thrust roller bearing, Axial spherical

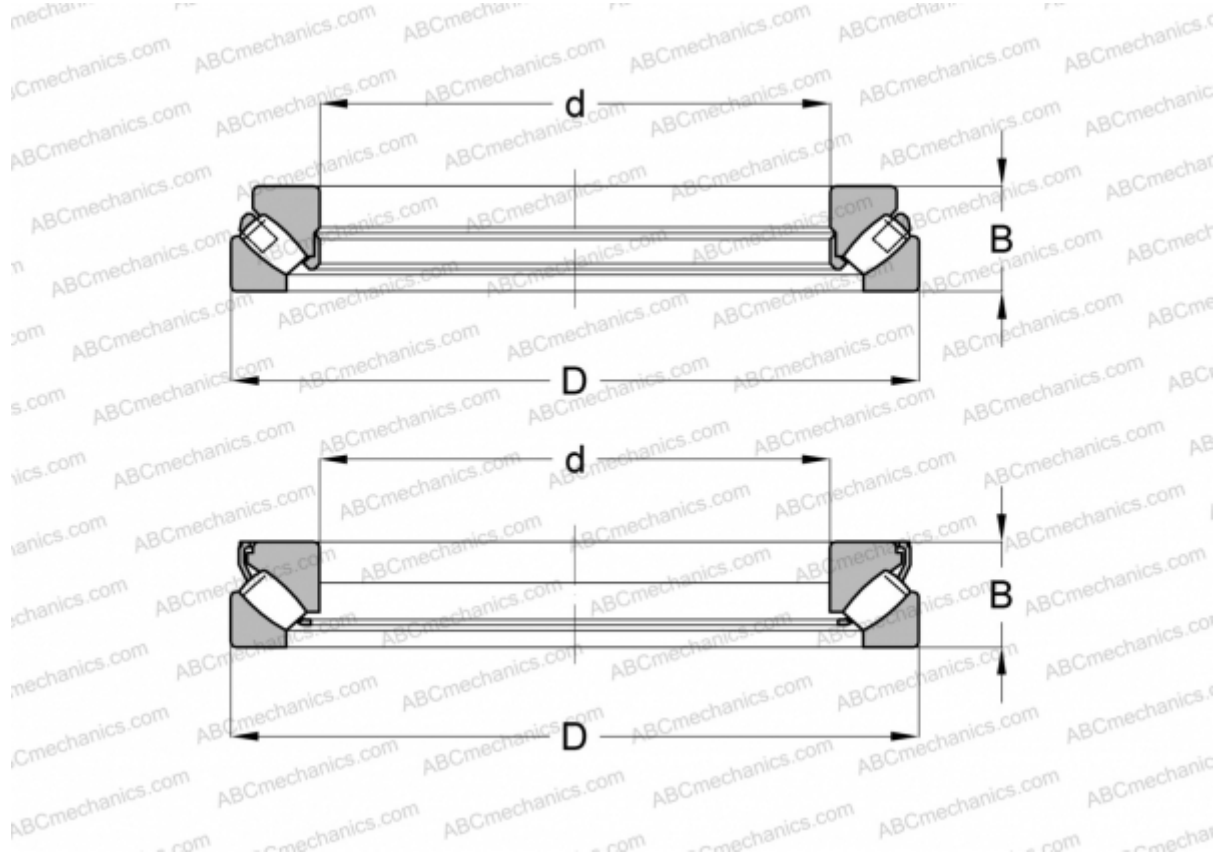

Technical specification

DIMENSIONS, MM

d	150,000
D	300,000
B	90,000

WEIGHT, KG 31,389

MANUFACTURER [ABC](#)

INTERCHANGE

FAG	29430 E
SKF	29430 E
TORRINGTON	29430