

29430 E FAG

Spherical roller thrust bearings

TYPE: Roller bearings, Thrust roller bearing, Axial spherical

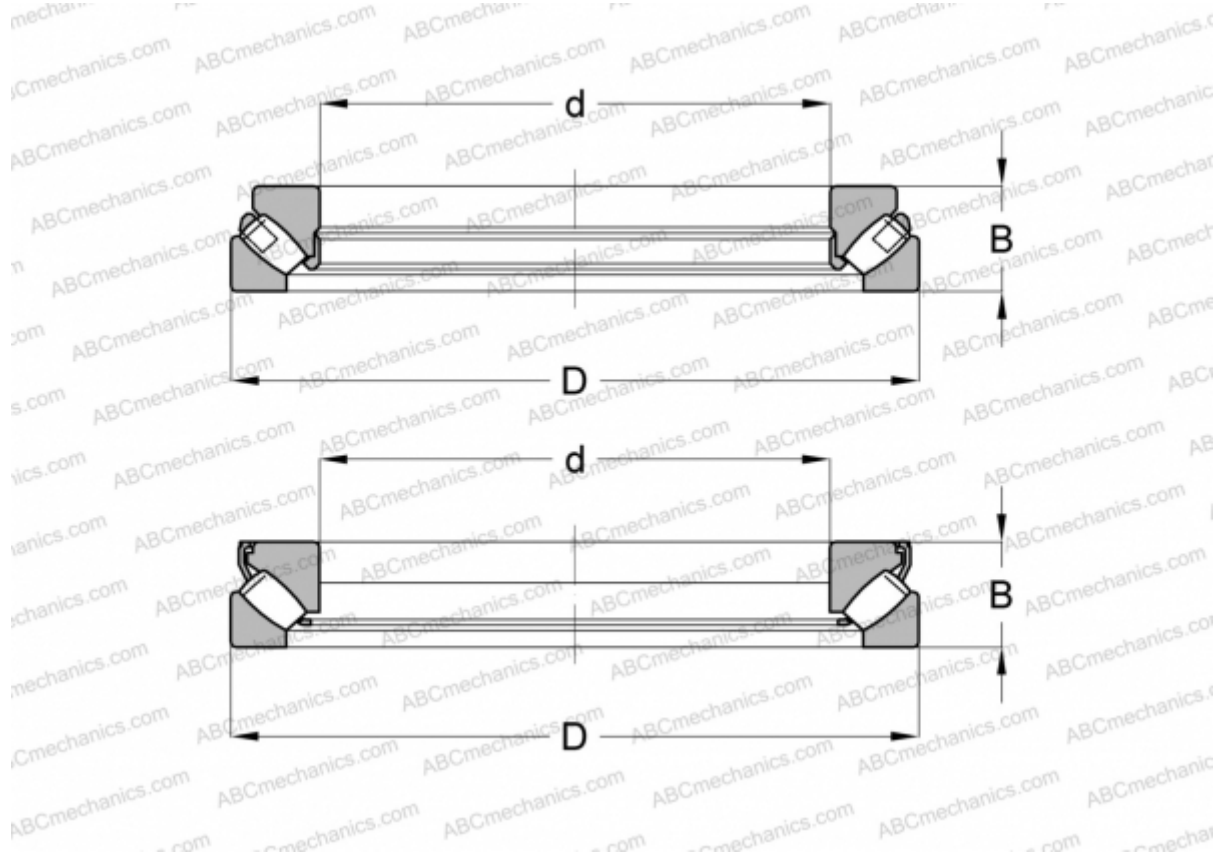

Technical specification

DIMENSIONS, MM

d	150,000
D	300,000
B	90,000

WEIGHT, KG 31,389

MANUFACTURER [FAG](#)

INTERCHANGE

ABC	29430E
SKF	29430 E
TORRINGTON	29430