

29332E ABC

Spherical roller thrust bearings

TYPE: Roller bearings, Thrust roller bearing, Axial spherical

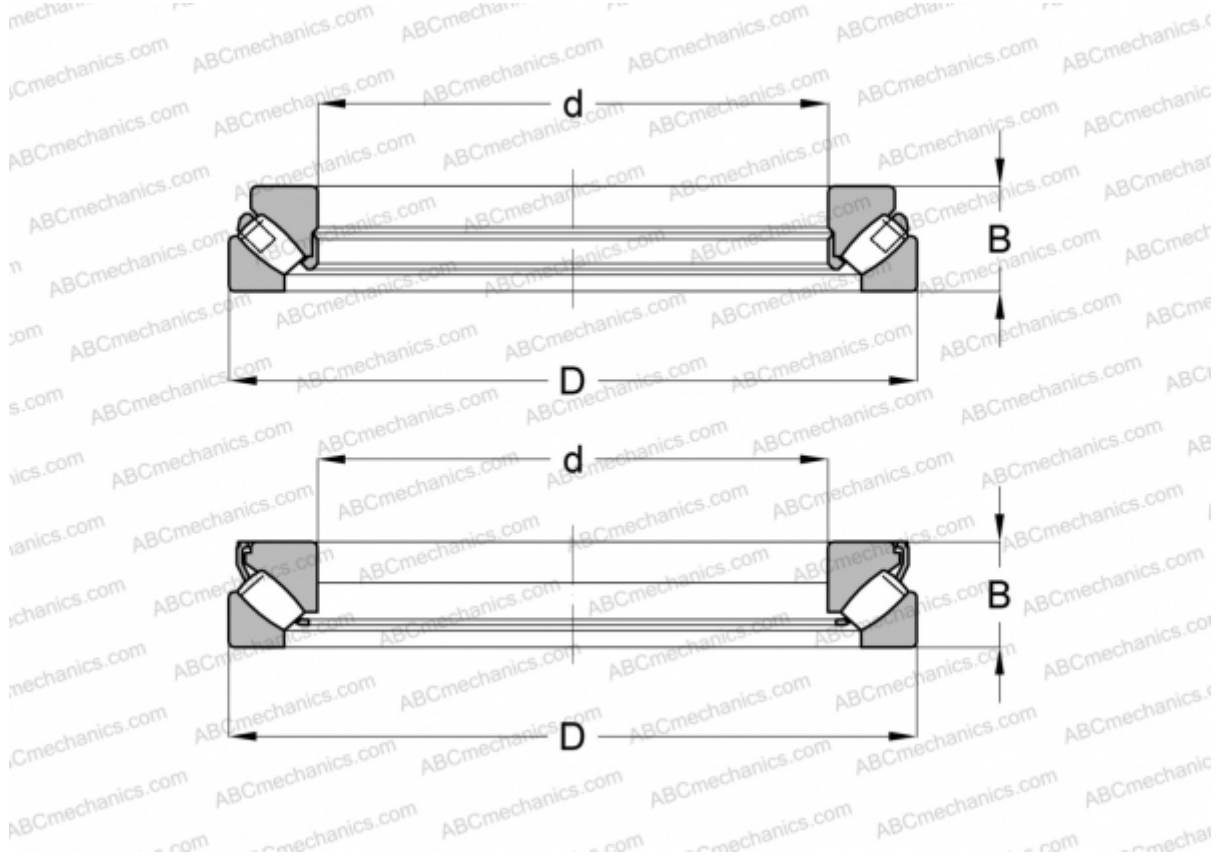

Technical specification

DIMENSIONS, MM

d	160,000
D	270,000
B	67,000

WEIGHT, KG 13,245

MANUFACTURER [ABC](#)

INTERCHANGE

FAG	29332 E
SKF	29332 E