

29332 E FAG

Spherical roller thrust bearings

TYPE: Roller bearings, Thrust roller bearing, Axial spherical

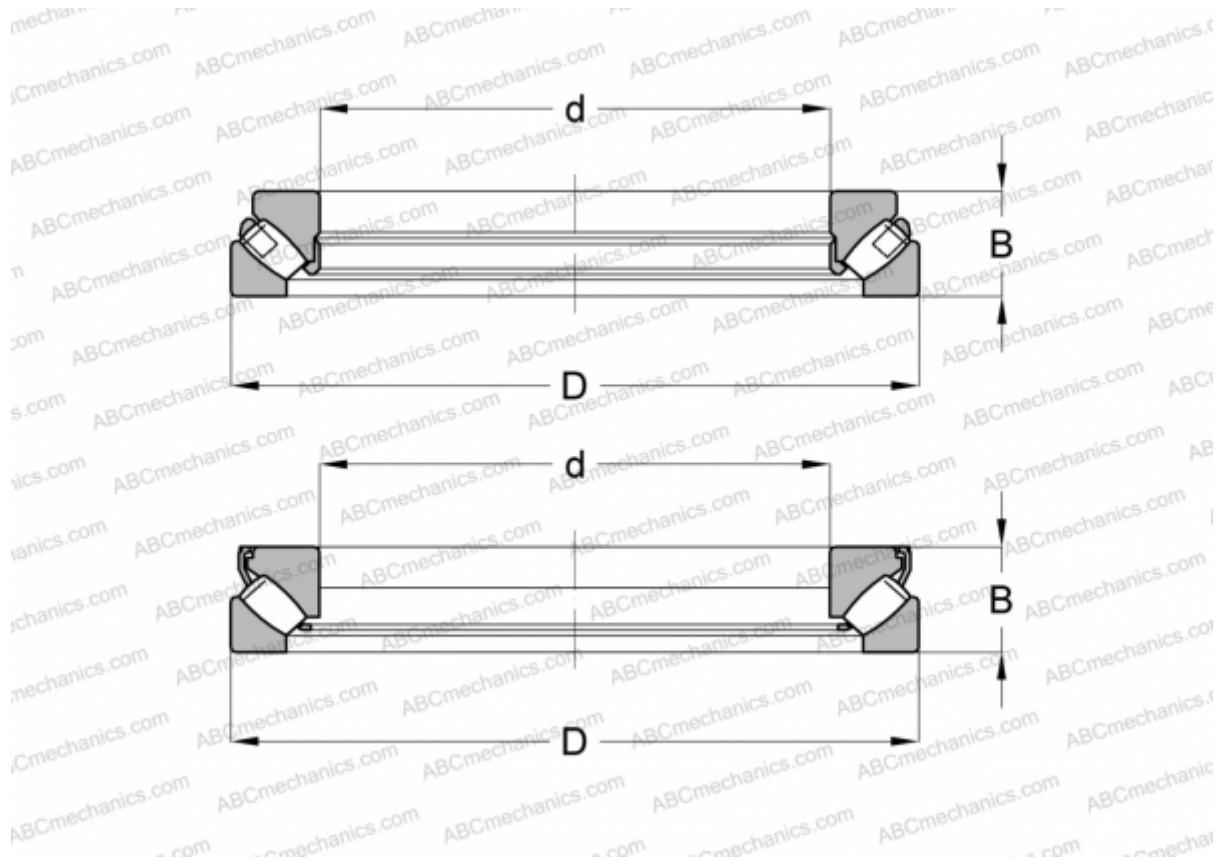

Technical specification

DIMENSIONS, MM

d	160,000
D	270,000
B	67,000

WEIGHT, KG 13,245

MANUFACTURER [FAG](#)

INTERCHANGE

ABC	29332E
SKF	29332 E