

29432E ABC

Spherical roller thrust bearings

TYPE: Roller bearings, Thrust roller bearing, Axial spherical

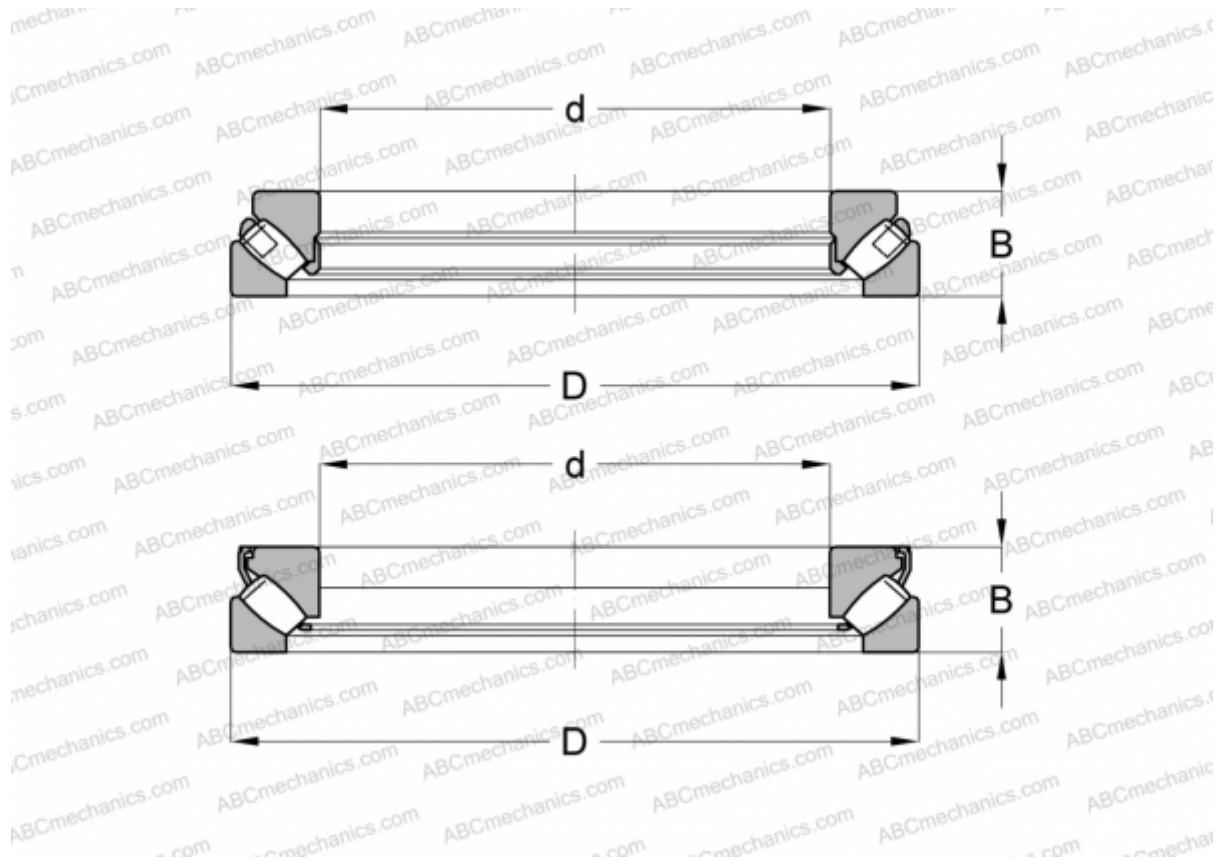

Technical specification

DIMENSIONS, MM

d	160,000
D	320,000
B	95,000

WEIGHT, KG 37,285

MANUFACTURER [ABC](#)

INTERCHANGE

FAG	29432 E
SKF	29432 E