

29432 E FAG

Spherical roller thrust bearings

TYPE: Roller bearings, Thrust roller bearing, Axial spherical

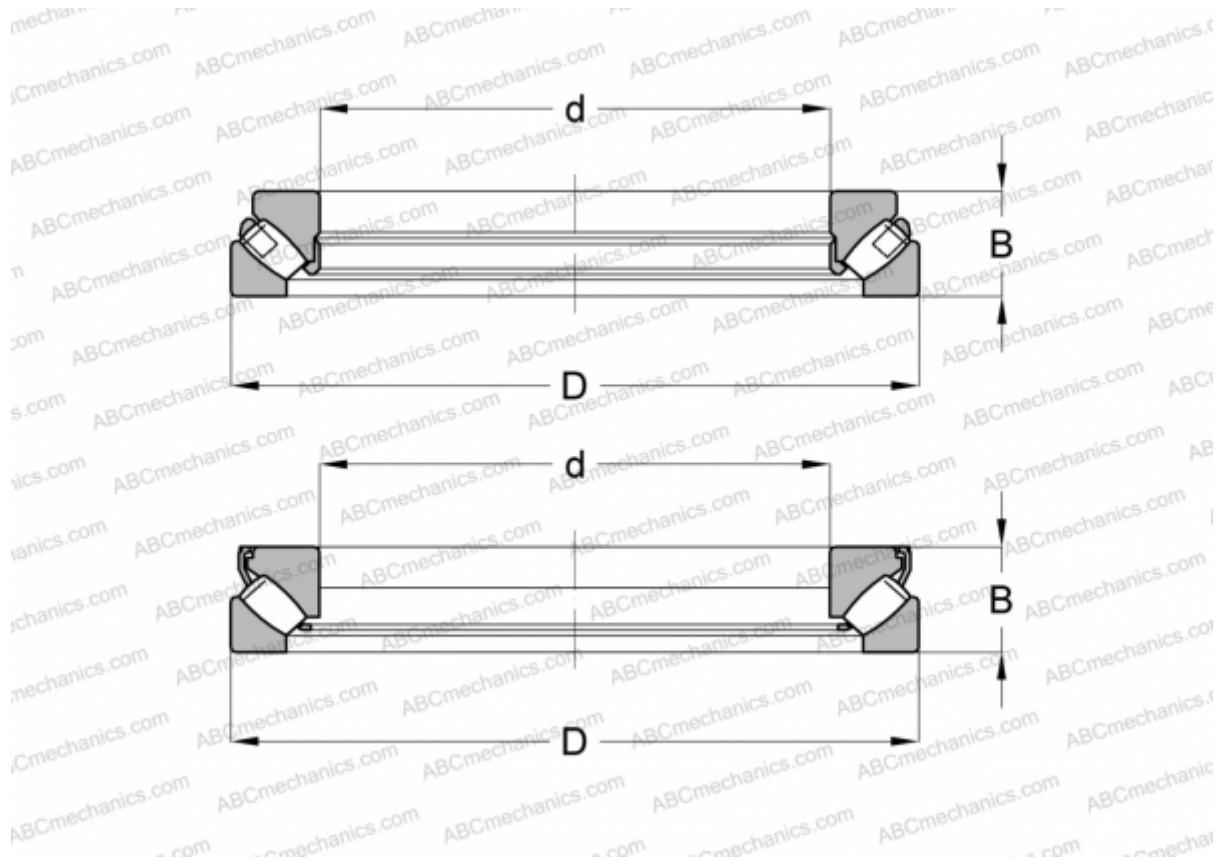

Technical specification

DIMENSIONS, MM

d	160,000
D	320,000
B	95,000

WEIGHT, KG 37,285

MANUFACTURER [FAG](#)

INTERCHANGE

ABC	29432E
SKF	29432 E