

29432 E SKF

Spherical roller thrust bearings

TYPE: Roller bearings, Thrust roller bearing, Axial spherical

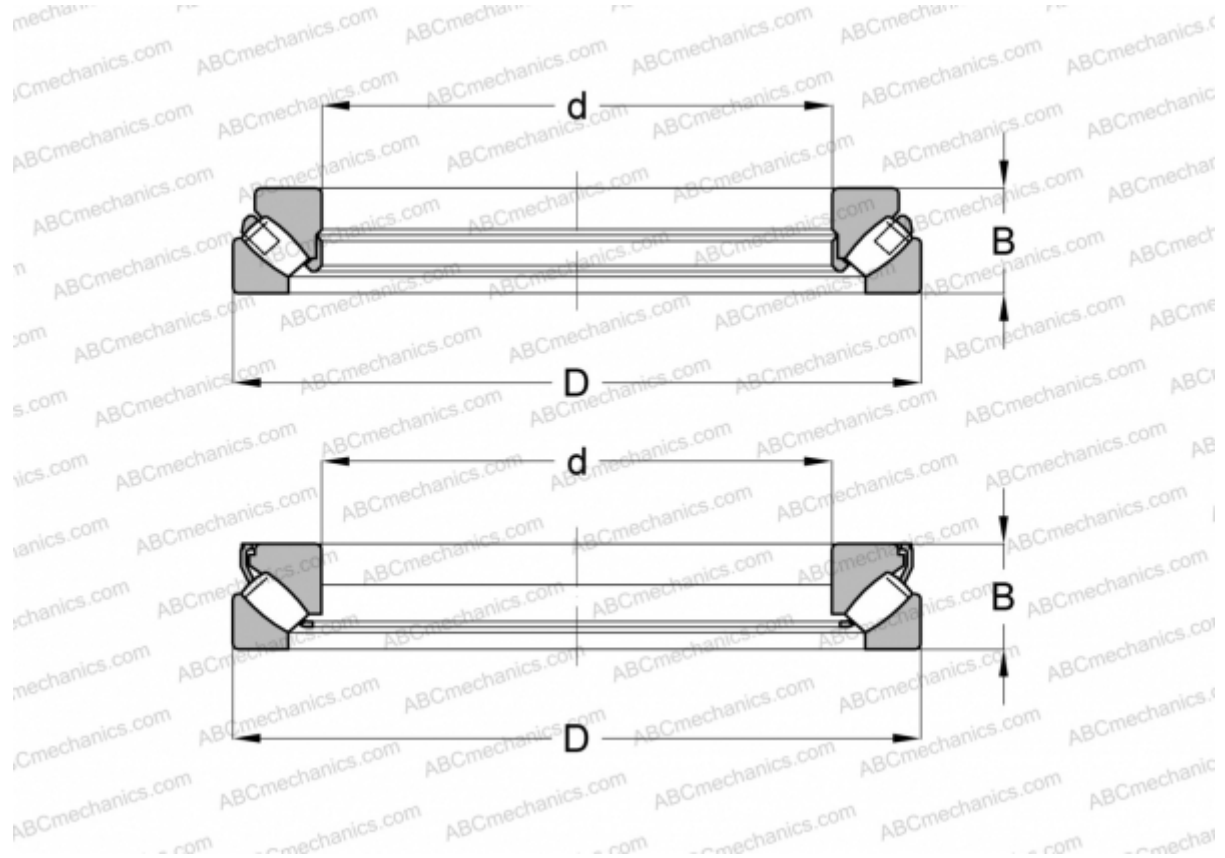

Technical specification

DIMENSIONS, MM

d	160,000
D	320,000
B	95,000

WEIGHT, KG 33,500

MANUFACTURER [SKF](#)

INTERCHANGE

ABC	29432E
FAG	29432 E

CALCULATION DATA

Basic dynamic load rating, C	2080,000 kN
Basic static load rating, Co	5600,000 kN
Fatigue load limit, Pu	570,000 kN
Reference speed	1100 r/min

CALCULATION DATA

Limiting speed	2000 r/min
----------------	------------